

iVISOOR *mentor QVGA* for National



Contents

General information

1

Important notes

2

Service menus

3

Troubleshooting

4

Appendix

Service Manual

Edition 5/2011 Rev. D

The order code for this document is
24 183 69 1001e_Rev D (National)

TABLE OF CONTENTS

1. General information	3
2. Important notes	5
3. Sensor calibration	6
3.1 Zero-setting the pressure signals.....	8
3.2 Zero-setting the slewing signal.....	10
3.3 Length sensor calibration procedure.....	12
3.4 Angle sensor calibration procedure.....	15
4. Spare Part Listings	18
4.1 Central Unit / Console	18
4.2 Pressure Transducer Block.....	19
4.3 Sensor, LWG508/13.....	20
4.4 A2B Spare Parts.....	21
5. Troubleshooting	23
5.1 General information.....	23
5.2 Error code list	24
Revision History	29

The manufacturer reserves the right to modify the contents of this manual without notice. Hirschmann will not be liable for errors contained in this manual or for incidental or consequential damages in connection with the furnishing, performance, or use of this manual. This document contains proprietary information, which is protected by copyright, and all rights are reserved. No part of this document may be photocopied, reproduced, or translated to another language without the prior written consent of Hirschmann. Hirschmann reserves proprietary rights to all drawings, photos and the data contained therein. The drawings, photos and data are confidential and cannot be used or reproduced without the written consent of Hirschmann. The drawings and/or photos are subject to technical modification without prior notice.

All information in this document is subject to change without notice.

1. GENERAL INFORMATION

This manual describes the service menus of the **iVISOR mentor QVGA** safe load indicator (SLI) and assists a service or maintenance person in identifying system malfunctions for National Cranes.

NOTE: Knowledge of system and CAN bus wiring is assumed.

REFERENCE: Refer to Operator's manual 24 183 19 1001e_Rev B (National) for detailed operation of the mentor QVGA.

The **iVISOR mentor QVGA** safe load indicator system for National Cranes comprises a central microprocessor unit with an integrated display and control console together with various sensors to record the measured values. The system components are connected via CAN bus.

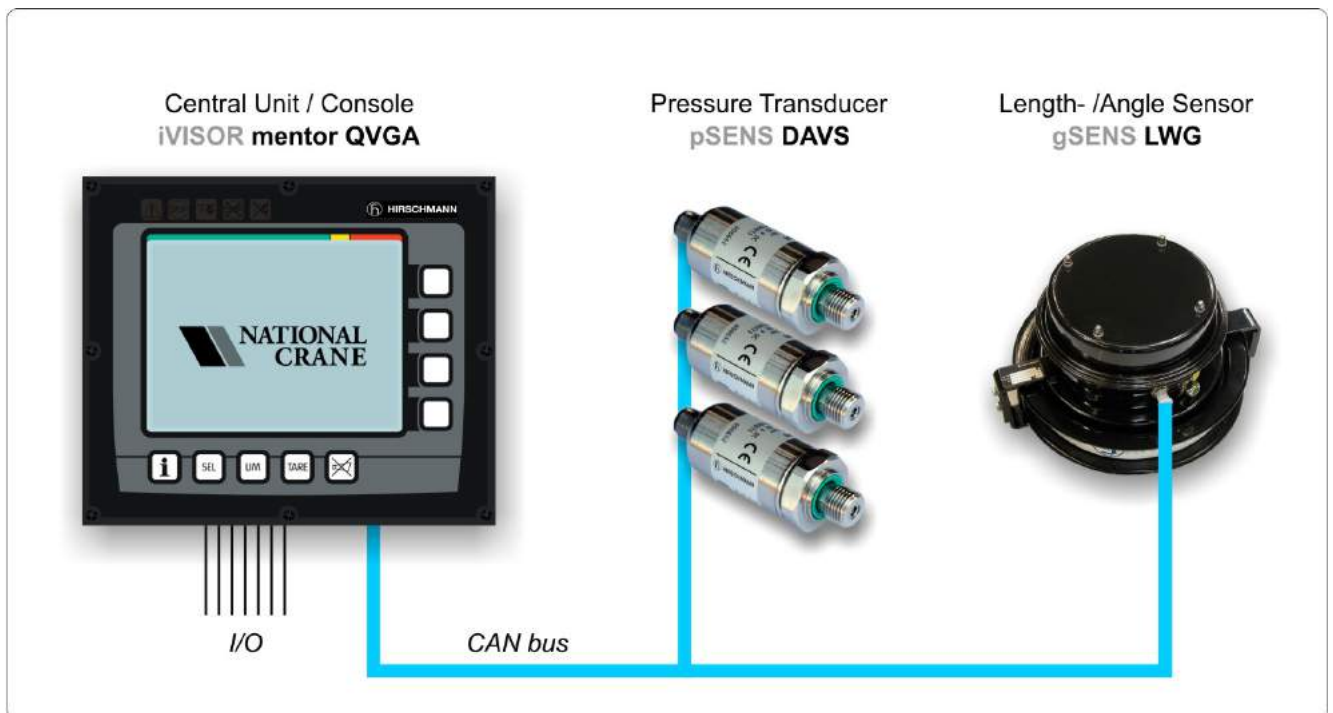

Components of the **iVISOR mentor QVGA** SLI system (without optional extras)

Configuration Setup

Components:



CPU/Console: The **iVISOR mentor QVGA** safe load indicator comprises a central microprocessor unit with an integrated display and operating console together with various sensors to record measured values. The system components are connected via CAN bus. The iVISOR mentor QVGA displays all geometrical information such as length and angle of main boom, working radius and tip height of the boom. It also displays the actual load and the maximum load permitted by load chart. Furthermore, it has an acoustical alarm, a warning light for overload, and a pre-warning light.

The graphic display allows for a simple interactive configuration setup, as well as sensor calibration (zero adjustment), and troubleshooting sensor output screen. The console has a warning light for anti-two-block conditions and an override switch for overload or anti-block condition.



Length-Angle Transducer: The length-angle sensor **gSENS LWG**, often referred to as the “cable reel”, is a combination of two transducers in one box, installed on the base section of the boom. It measures the length and the angle of the boom. A reeling drum drives a potentiometer, which is the length transducer. Part of the length transducer circuit is the length cable on the drum, which is a multi-conductor cable. It is connected to the anti-two-block switch at the boom head and to a slip ring body in the LWG. The angle transducer is a potentiometer driven by a weighted pendulum that is oil damped. Both length and angle transducer are connected to a CAN bus controller board, which is connected to the bus system.



Pressure Transducer(s): A pressure transducer **pSENS DAVS** converts hydraulic pressure into a CAN signal. One (or two) pressure transducer is (are) connected to the piston side of the lift cylinder and one to the rod side.

2. IMPORTANT NOTES

The SLI is an operating aid that warns the crane operator of imminent overloading or of the approach of the hook block to the boom head, in order to avoid possible property damage or injury to personnel.

The device is not, nor is it intended to be, a substitute for good operator judgment and/or experience, nor does it remove the need for utilizing only recognized safe procedures during crane operations.

**CAUTION**

The crane operator continues to bear ultimate responsibility for safe operation of the crane. He must ensure that he fully understands and follows the displayed notes and instructions in their entirety.

**WARNING**

The SLI is not able to provide aid to the crane operator unless it has been properly adjusted and unless the correct load capacity chart and the correct operating code have been entered for the respective rigging configuration. The correctness of the SLI settings must be guaranteed before beginning crane work in order to avoid damage to property and severe or even fatal injuries to personnel.

**WARNING**

This system can be equipped with an external key-operated switch located in the crane operator's cab. This key-operated switch overrides control lever function switch-off by the SLI or by the hoist limit switch system. This switch may only be used during emergency situations, and even then only by authorized personnel. Failure to observe these instructions could result in damage to property and severe or even fatal injuries to personnel.

**WARNING**

The SLI cannot perform correctly unless it has been properly adjusted. The prerequisite for this is making conscientious and correct entries during the set-up procedure, in accordance with the actual configuration of the crane. The correctness of the SLI settings must be ensured before beginning crane work in order to avoid damage to property and severe or even fatal injuries to personnel.

Sensor Calibration

3. Sensor Calibration

In this code-protected area, settings affecting system precision can be made by trained service personnel. For access to the calibration menus it is necessary to input a matching 5-digit code.

To start the function:



Actuate the INFO key.

▼ Info screen

AI	raw	mV	phys.	DIG I/O
⇒	18.5	1240	49.7	
P-P	54.5	2678	2403.	Key
P-R	17.7	1206	808.9	Header
↗	55.3	2713	40.2	
↘	68.4	3237	102.5	
				↩

to service menus

back

▼ Entry to calibration menus



Please enter servicecode:
55555

ESC

+

-

OK

abort input of service code

increase marked numeric value

reduce marked numeric value

mark the next figure, access after the last valid figure

If an invalid service code is entered, you are prompted to enter it again or to abort the input.

Sensor Calibration

After entering the service menu you can follow the calibration procedure step by step or can select the type of calibration by scrolling with function key . Press "ESC" to finish calibration procedure:

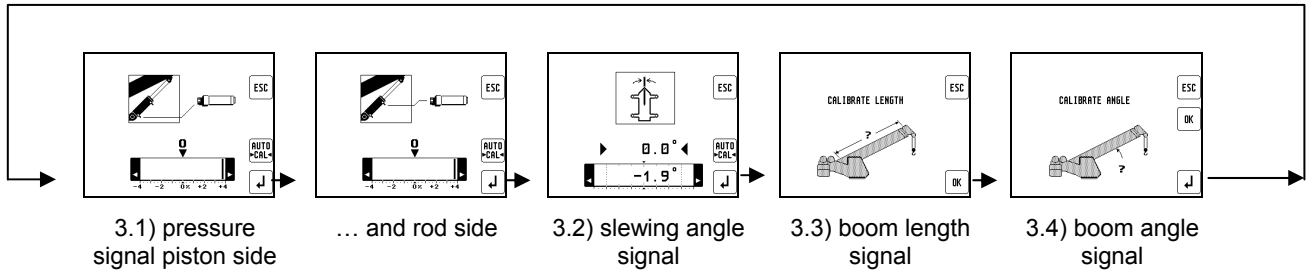

3.1 Zero-setting the pressure signals

NOTE: The only thing adjustable for the pressure transducers is the zero point, which is the signal the transducer outputs when there is no (zero) pressure sensed.



Ensure there is no pressure in the hydraulic line when disconnecting the hoses from pressure transducers!





The display shows which transducer (piston-side, rod-side or force) is being zeroed and a horizontal dial marks the present pressure (or force) difference in %.

NOTE: there are two calibration screens: for piston and for rod transducer.

NOTE: The operating range for zero-setting this value is from **-1%** to **+1%**.

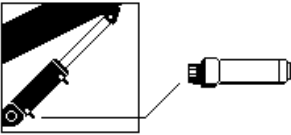
Press and release the “AUTO >CAL<” key multiple times until the zero-setting starts. The indicator line must move to zero on the dial, otherwise the zero-setting of this value is not correct!

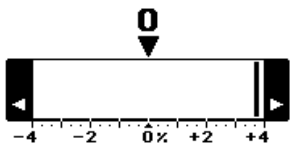
▼ Zero point adjustment, pressure piston side:

		leave the service menu
		carry out zero point setting
		skip calibration step / go to next menu

Sensor Calibration

▼ Zero point adjustment, pressure rod side:

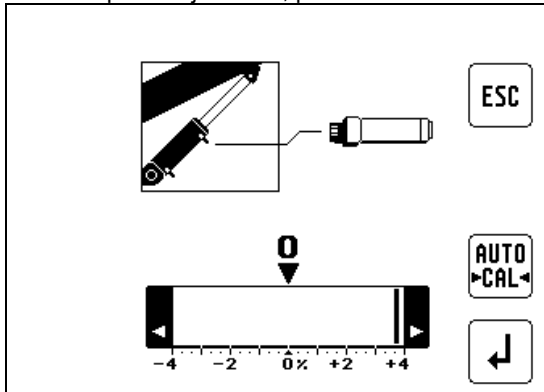

ESC

leave the service menu

AUTO
CAL

carry out zero point setting



skip calibration step / go to next menu

Sensor Calibration

3.2 Zero-setting the slewing signal

NOTE: The only thing adjustable for the slew potentiometer is the zero point, which is complete when the boom is at the 0° and 180° position of the crane.



NOTE: The range for zero-setting this value is from -10° to +10°./ ±170° to 190°

Press the “AUTO >CAL<” key until the zero-setting starts. The indicator line must move to zero on the dial, otherwise the zero-setting of this value is not correct!

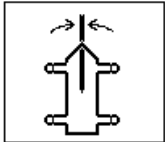
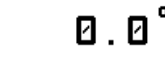
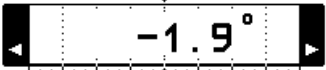
▼ Zero point setting, slewing angle 0° position:

	ESC	leave the service menu
	AUTO >CAL<	carry out zero point setting slewing angle for 0° position
	↵	skip calibration step / go to next menu

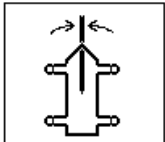
▼ Zero point setting, slewing angle 180° position:

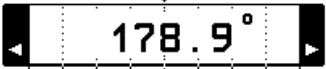
	ESC	leave the service menu
	AUTO >CAL<	carry out zero point setting slewing angle for 180° position
	↵	skip calibration step / go to next menu

Sensor Calibration

3.3 Length sensor calibration procedure

NOTE: The length sensor can be calibrated for its zero point and its full range.

With retracted boom, the potentiometer of the length sensor has to be at its 0 position, which is all the way counter-clockwise. For extended boom, the adjustment is done by software as described below.

The length should be calibrated to be about 0.1 feet (or 0.05m for metric) accurate for retracted and extended lengths. Perform the following steps:

▼ Start screen zero point adjustment, boom length:

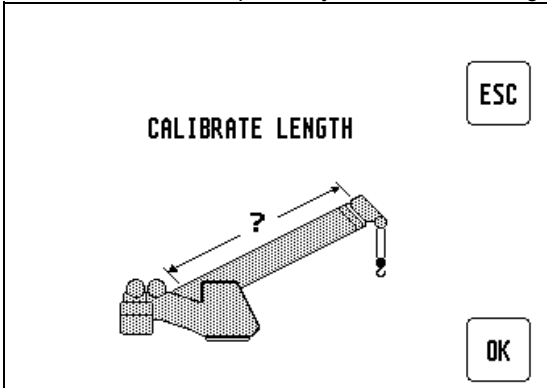
	ESC	leave the service menu
	OK	Start length calibration

▼ Start screen min. boom length:

	ESC	leave the service menu
	↩	skip calibration step / go to next menu

- Fully retract the main boom and check if indicated length is within 0.1 feet (or 0.05m for metric) of actual retracted boom length.
- If it is not, adjust length potentiometer mechanically as described below:

Sensor Calibration

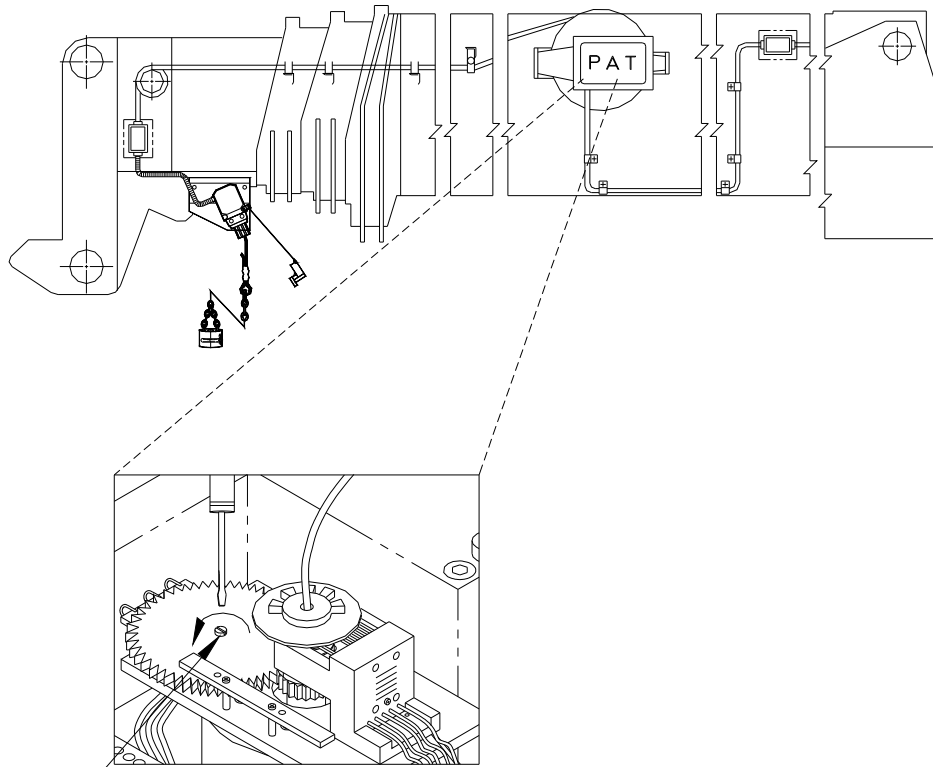

ADJUST LENGTH POTENTIOMETER, WITH BOOM FULLY RETRACTED
TURN THE CENTER SCREW COUNTER CLOCKWISE TO A SOFT STOP.

- With boom fully retracted turn the center screw of the length pot unit counter clockwise to a soft stop.
- During adjustment an additional button "OK" appears. Check value and set actual length as fully retracted length by pressing OK.

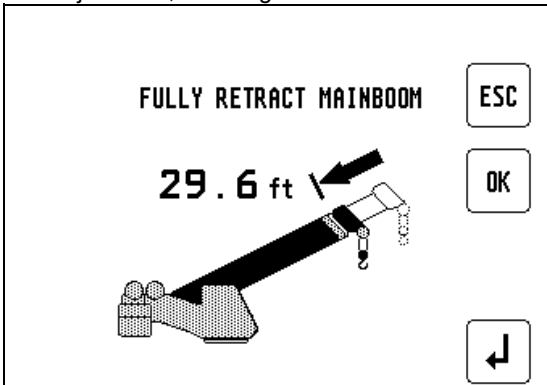

▼ Adjustment, min length:

	ESC	leave the service menu
	OK	carry out min. boom length setting
	↵	skip calibration step / go to next menu

Afterward next calibration screen appears:

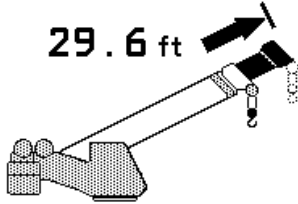

Sensor Calibration

▼ Start screen maximum. boom length:

	ESC	leave the service menu
		skip calibration step / go to next menu

- Now extend main boom all the way out. Make sure you are within the allowed operating range (especially maximum radius).
- During telescoping out the boom an additional button "OK" appears.

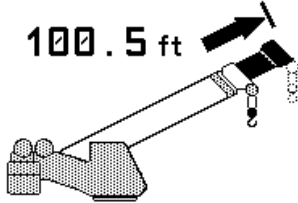
▼ Adjustment, maximum length:

	ESC	leave the service menu
	OK	carry out max. boom length setting
		skip calibration step / go to next menu

- Check whether boom is fully extended, then press "OK". Afterward next calibration step (angle) appears.

Sensor Calibration

3.4 Angle sensor calibration procedure

The angle sensor can be calibrated for its zero point, with steep boom (75°) and one or two additional angle values (40° / 65°)

Material required: calibrated inclinometer

▼ Start screen adjustment, boom angle:

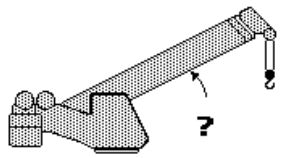
 <p>CALIBRATE ANGLE</p>	ESC	leave the service menu
	OK	Start angle calibration procedure
	↵	

▼ Start calibration for "zero degree" angle:

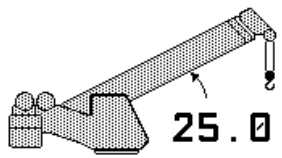
 <p>BOOM ANGLE MECH. 0-CAL.</p> <p>25.0</p>	ESC	leave the service menu
	OK	
	↵	skip calibration step / go to next menu

Sensor Calibration

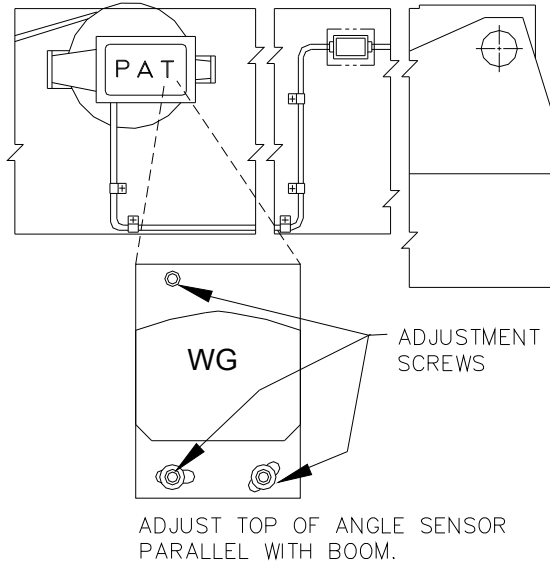

- Boom down.
- Release adjustment screws of the angle sensor.
- Mechanically adjust top of angle sensor housing exact parallel with boom by help of inclinometer.
- Fix adjustment screws of the angle sensor.

Having adjusted the angle sensor, mechanically check value and press "OK" for the next step.

▼ Calibration for "zero degree" angle:

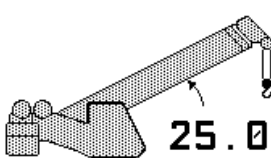
<p>BOOM ANGLE MECH. 0-CAL.</p>  <p>25.0</p>	ESC	leave the service menu
	OK	calibrate next angle
	↵	skip calibration step / go to next menu

- Now boom up to 40°, (range is 35° - 45°)

▼ Calibration for "40°" angle:

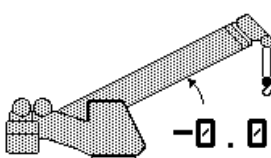
<p>BOOM TO</p> <p>40.0°</p>  <p>-0.0</p>	ESC	leave the service menu
		calibrate next angle
	↵	skip calibration step / go to next menu

Sensor Calibration

When the boom angle is within the calibration range, the screen will add the 'CHANGE ?' / 'SET' and 'OK' text as shown below:

▼ Calibration for "40°" angle:

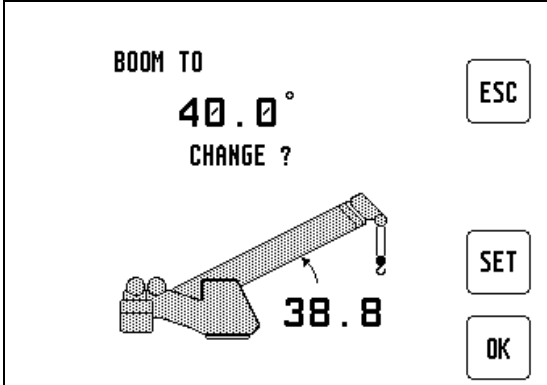
	ESC	leave the service menu
	SET	adjust actual angle
	OK	set current angle to defined angle

- Measure the boom angle with the inclinometer and when the boom is positioned in the calibration range, compare the measured angle to the displayed angle.
- If the indicated angle is within +/- 0.1 degrees of the measured angle, confirm with 'OK'. Otherwise, select 'SET' to adjust the angle.

▼ Adjust "40°" angle:

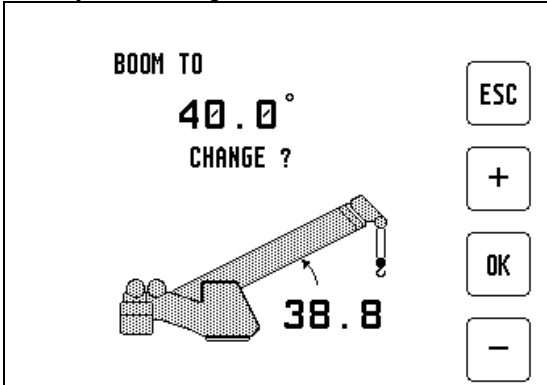
	ESC	leave the service menu
	+	increase angle value by 0.1°
	OK	Confirm
	-	decrease angle value by 0.1°

- Once you push 'SET', the screen is going to change to the angle adjustment screen. Use the '+' and '-' buttons to adjust the indicated angle to match the measured angle.
- When the display shows the correct angle, press 'OK'.



Press **ESC** to leave sensor adjustments and return to normal LMI screen.

- **Now repeat procedure as shown for the boom angle 65° and 75°.**

If values were modified a confirmation screen appears at the end:

Sensor Calibration

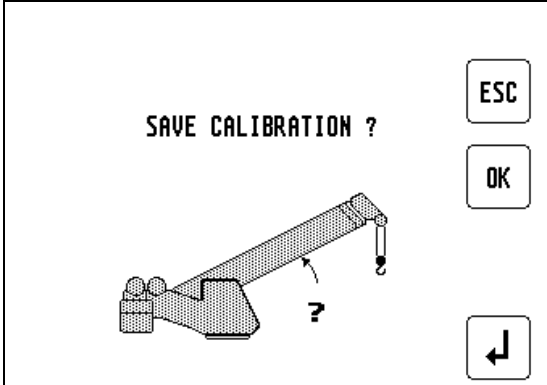
▼ Confirmation screen

	ESC	leave the service menu
	OK	YES, I confirm
		NO, go to next menu

- When you are sure to save this calibration, press 'OK'. Normal LMI screen appears. Otherwise press "Return" for restart the calibration procedure

Press **ESC** to leave sensor adjustments and return to normal LMI screen.

Sensor Calibration

4. Spare Part Listings

4.1 Central Unit / Console iVISOR Mentor QVGA / 1001 PART NO. 024-183-061-001

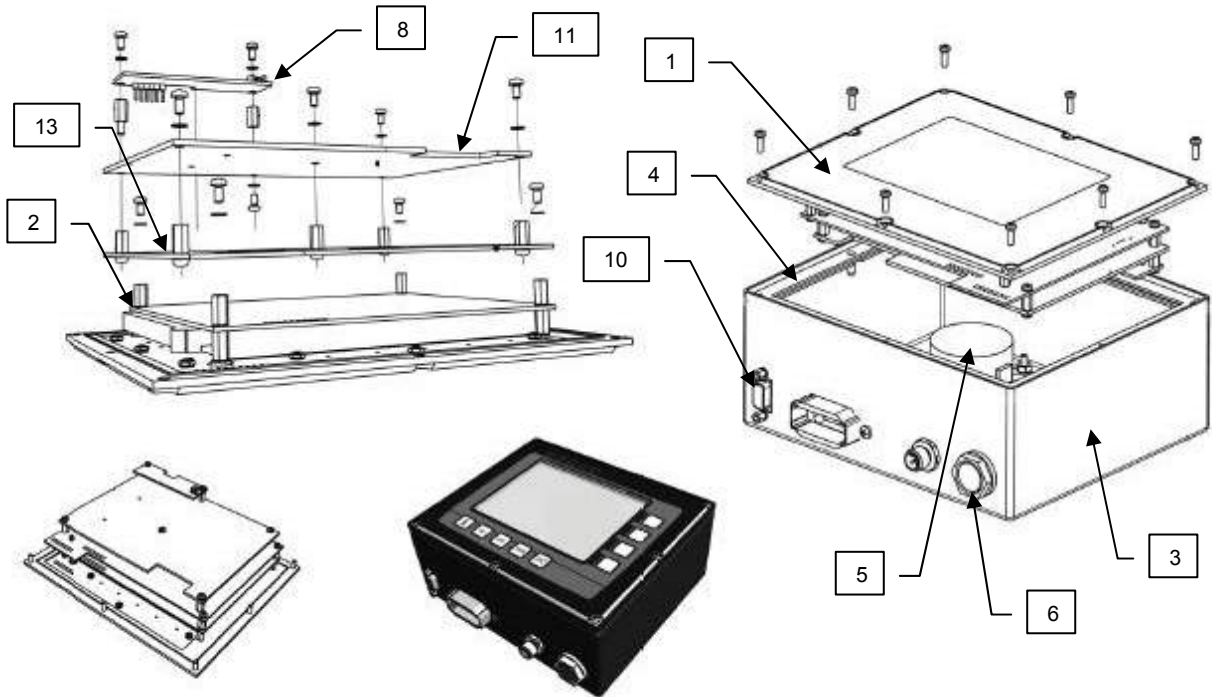

NO.	PART NO.	SAP NO.	QTY	DESCRIPTION
1	024-183-100-010	534626	1	FRONT PANEL, MENTOR QVGA w/DISPLAY
1	024-183-100-201	534586	1	FRONT PANEL, 1001 SQ183 kpl. HIRSCHMANN
2	050-000-100-298	534603	1	LCD, UNIT
3	024-183-100-009	534589	1	HOUSING, 0009 MENTOR QVGA
4	024-183-050-007	534590	1	FLAT SEAL
5	024-183-290-002	534170	1	PIEZO-TRANSMITTER CPT 45A
6	024-000-100-095	524167	1	PRESSURE COMP. ELEMENT 0095 cpl.
7*	202-10-0003	325577	1	PRESSURE COMP. ELEMENT SELF ADHESIVE
8	024-183-300-005	534199	1	REAL TIME CLOCK SQ183 EVENT RECORDER
9*	024-050-300-117	532477	1	BATTERY MODULE EVENT RECORDER
10	301-11-1042	324626	1	PROTECTION CAP D-SUB CONN. 9P
11	024-183-300-004	535243	1	MAIN BOARD 0004 MENTOR QVGA
12*	313-10-2001	306503	1	ATO MINI FUSE 2A (SAE J 2077)
13	024-183-301-001	534617	1	ADAPTER BOARD 1001 MENTOR QVGA

* Not shown

Sensor Calibration

4.2 Pressure Transducer Block, DAV314/0014 PART NO. 044-314-060-014

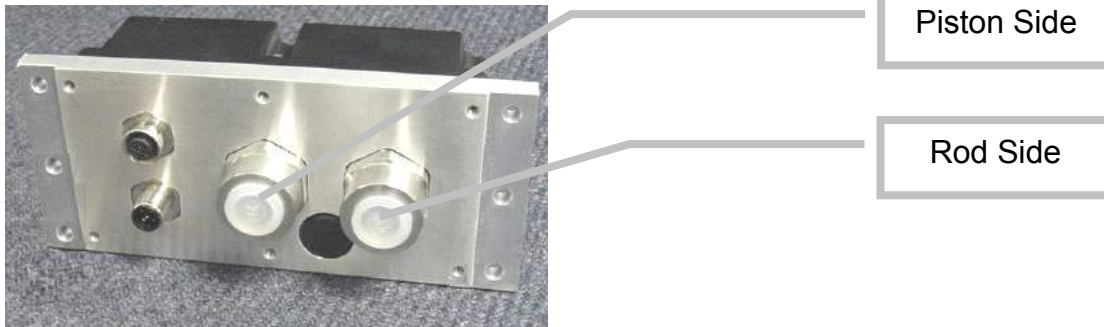

Cutting ring for pressure transducers
PART NO. 000-209-140-016

Hydraulic bulkhead adapter 9/16-18 JIC 37° x 16m x 1.5
PART NO. 000-214-600-093



CAN bus from pressure transducer to cable reel.
PART NO. 031-300-060-454

Sensor Calibration

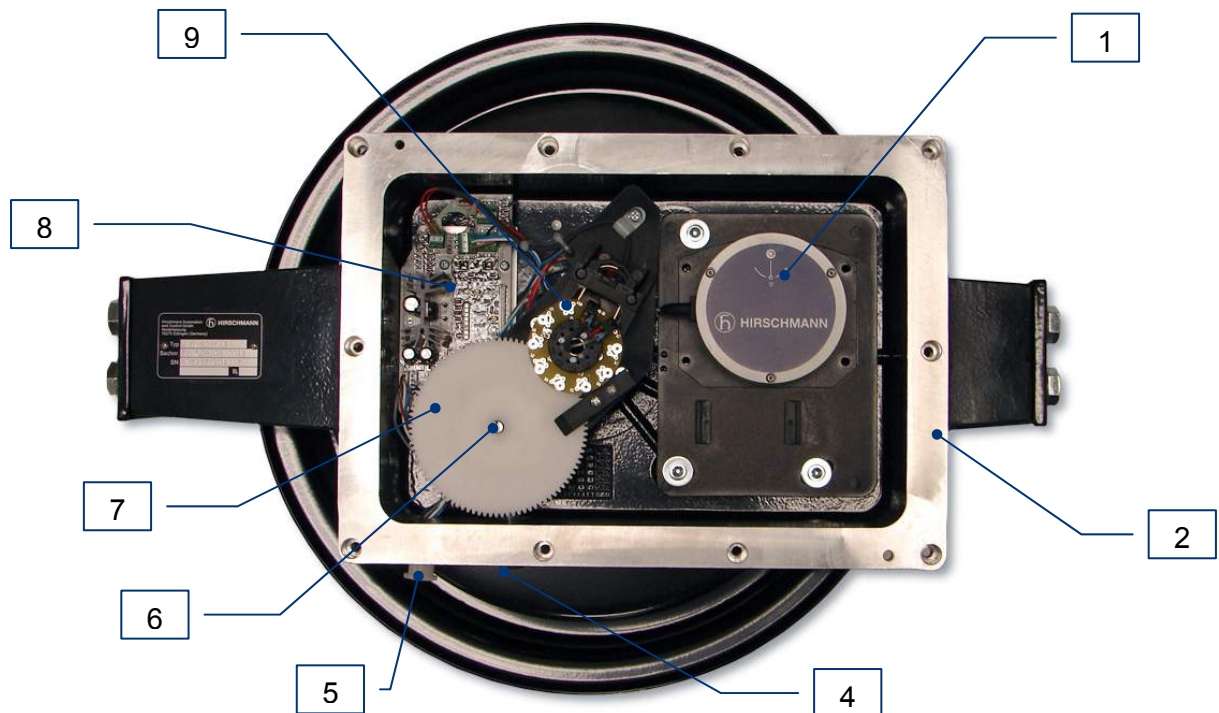
4.3 SENSOR, LWG508/13 W/ 60M 151 ANGLE, 037 LENGTH

#	Part #	SAP #	Qty	Description
1	064-360-061-551	606700	1	Sensor, Angle, WGC360/1551
2	068-000-110-133	530333	1	Cable Reel Housing, W/Cable Drum & Springs
3*	000-673-020-002	311033	197'	Cable, Length Sensor, 1 Core W/Shield
4	325149	325149	1	Connector, Female, M12 W/Cable
5	092-000-060-387	529959	1	Connector, Male, M12 W/Cable
6	067-000-300-013	531527	1	Length Pot, W/Cable & Plug
7	067-000-050-126	534466	1	Gear Wheel, T=96
8	068-000-300-104	534340	1	Board, Connection
9	068-000-110-107	518748	1	Kit, Slip Ring, 2 Conductor
10*	005-682-000-001	518697	1	Cable Reel Cover W/Gasket

Sensor Calibration

4.4 A2B Spare Parts



031-300-050-276 A2B Mounting standoff



031-300-050-264 A2B mounting plate



003-100-210-012 Weight and chain
031-300-100-037 Chain connector, quick link



031-300-050-272 Lynch pin



031-300-060-377 Cable Assembly 12' Note: part number may change depending on length.

Troubleshooting

5. TROUBLESHOOTING

5.1 General information

In the event of a malfunction, if the range is not reached or is exceeded or if an operating error is detected by the system, a message appears on the data display (1) starting with an “E” followed by a two-digit code which indicates the reason for the malfunction.



The error codes listed in the following table describe the various error codes which can be displayed in this system.

Faults in the microprocessor system must be dealt with only by the manufacturer's trained customer service personnel. If faults occur, please contact Hirschmann Service USA:

www.hirschmann.com > USA > Electronic Control Systems > Contact - ECS.

Error Code List

5.2 Error code list (System program LSQN V 1.xx)

Error Code	Error	Cause	Elimination
E01	Fallen below radius range or angle range exceeded	<ul style="list-style-type: none"> Fallen below the minimum radius or gone past the maximum angle specified in the respective load chart due to luffing up the boom too far 	<ul style="list-style-type: none"> Luff down the boom to a radius or angle specified in the load chart.
E02	Radius range exceeded or fallen below angle range	<ul style="list-style-type: none"> Gone past the maximum radius or fallen below the minimum angle specified in the respective load chart due to luffing down the boom too far 	<ul style="list-style-type: none"> Luff up the boom to a radius or angle specified in the load chart.
E03	Non-permitted slewing zone (no load area)	<ul style="list-style-type: none"> The slewing zone with load is not permitted 	<ul style="list-style-type: none"> Slew to permitted area
E04	Operating mode not acknowledged or non permitted slewing zone	<ul style="list-style-type: none"> A non existing operating mode has been selected 	<ul style="list-style-type: none"> Set the correct operating mode for the operating state in question
		<ul style="list-style-type: none"> The boom is in a non-permitted slewing zone 	<ul style="list-style-type: none"> Slew the boom to a permitted area.
E05	Prohibited length range	<ul style="list-style-type: none"> Boom has been extended either too far or not far enough, e.g. if it is prohibited to go beyond a certain maximum boom length or with load curves for jibs where the main boom has to be extended to a certain length 	<ul style="list-style-type: none"> Extend/retract boom to the correct length
		<ul style="list-style-type: none"> Length sensor adjustment has changed, e.g. the cable slid off the length sensor reel. 	<ul style="list-style-type: none"> Retract boom. Check the prestress of the cable reel (cable must be taut). Open the length sensor and carefully turn the length sensor pot counterclockwise until the detent by means of a screw driver
		<ul style="list-style-type: none"> Clutch between length sensor pot and drive is defective 	<ul style="list-style-type: none"> Replace the complete clutch including drive wheel and adjust length sensor pot as described above
E06	Radius range exceeded or fallen below angle range with luffing jib operation	<ul style="list-style-type: none"> Maximum radius as specified in the load chart exceeded or fallen below minimum angle due to luffing down the luffing jib too far 	<ul style="list-style-type: none"> Luff the jib to a radius or angle specified in the load chart.
E11	Fallen below lower limit value for measuring channel "length main boom"	<ul style="list-style-type: none"> Length potentiometer is defective PDB variable for analog value not supported 	<ul style="list-style-type: none"> Replace length potentiometer Setup of correct PDB variable for analog value in DGA6.i.3
		<ul style="list-style-type: none"> Electronic component in the measuring channel is defective 	<ul style="list-style-type: none"> Replace sensor unit

Error Code List

Error Code	Error	Cause	Elimination
E12	Fallen below the lower limit value in the measuring channel "pressure piston side"	<ul style="list-style-type: none"> Pressure transducer is defective. PDB variable for analog value not supported 	<ul style="list-style-type: none"> Replace pressure transducer Setup of correct PDB variable for analog value in DGA6.i.3
		<ul style="list-style-type: none"> Electronic component in the measuring channel is defective. 	<ul style="list-style-type: none"> Replace sensor unit
E13	Fallen below lower limit value in the measuring channel "pressure rod side"	<ul style="list-style-type: none"> refer to E12 	<ul style="list-style-type: none"> refer to E12
E14	Fallen below lower limit value in measuring channel "force"	<ul style="list-style-type: none"> Force transducer defective Electronic component in the measuring channel is defective. 	<ul style="list-style-type: none"> Replace force transducer Replace sensor unit
E15	Fallen below lower limit value in measuring channel "angle main boom"	<ul style="list-style-type: none"> Angle potentiometer defective PDB variable for analog value not supported 	<ul style="list-style-type: none"> Replace angle sensor Setup of correct PDB variable for analog value in DGA6.i.3
		<ul style="list-style-type: none"> Electronic component in the measuring channel defective. 	<ul style="list-style-type: none"> Replace sensor unit
E16	Fallen below lower limit value in measuring channel "angle 2"	<ul style="list-style-type: none"> Angle potentiometer defective 	<ul style="list-style-type: none"> Replace angle sensor
		<ul style="list-style-type: none"> Electronic component in the measuring channel defective. 	<ul style="list-style-type: none"> Replace sensor unit
E17	Fallen below lower limit value "length telescope I (+II)"	<ul style="list-style-type: none"> Length potentiometer defective 	<ul style="list-style-type: none"> Replace length sensor.
		<ul style="list-style-type: none"> Electronic component in the measuring channel defective 	<ul style="list-style-type: none"> Replace sensor unit
E18	Front outrigger overloaded	<ul style="list-style-type: none"> Front outrigger overloaded 	<ul style="list-style-type: none">
E1A	Fallen below lower limit value in measuring channel "slewing angle 1". slew below allowed range	<ul style="list-style-type: none"> Cable between the central unit and the slewing angle sensor defective or loose. Water inside the plug of the angle sensor 	<ul style="list-style-type: none"> Check cable as well as plugs, replace, if need be.
		<ul style="list-style-type: none"> 1-cannel slew sensor min. value DGA 11.5.7 <> 0 	<ul style="list-style-type: none"> move to allowed slew range
		<ul style="list-style-type: none"> Slewing angle potentiometer is defective 	<ul style="list-style-type: none"> Replace slewing angle sensor
E1B	Fallen below lower limit value in measuring channel "slewing angle 2"	<ul style="list-style-type: none"> Electronic component in the measuring channel defective 	<ul style="list-style-type: none"> Replace sensor unit
		<ul style="list-style-type: none"> refer to E1A 	<ul style="list-style-type: none"> refer to E1A
E1C	Fallen below lower limit	<ul style="list-style-type: none"> Angle potentiometer defective 	<ul style="list-style-type: none"> Replace angle sensor

Error Code List

Error Code	Error	Cause	Elimination
	value in measuring channel "luffing jib angle"	<ul style="list-style-type: none"> Electronic component in the measuring channel defective. 	<ul style="list-style-type: none"> Replace sensor unit
E21	Upper limit value in measuring channel "main boom length" has been exceeded.	<ul style="list-style-type: none"> refer to E11 	<ul style="list-style-type: none"> refer to E11
E22	Upper limit value in measuring channel "pressure piston side" has been exceeded	<ul style="list-style-type: none"> refer to E12 	<ul style="list-style-type: none"> refer to E12
E23	Upper limit value in measuring channel "pressure rod side" has been exceeded.	<ul style="list-style-type: none"> refer to E12 	<ul style="list-style-type: none"> refer to E12
E24	Upper limit value in measuring channel "force" has been exceeded.	<ul style="list-style-type: none"> refer to E14 	<ul style="list-style-type: none"> refer to E14
E25	Upper limit value in measuring channel "main boom angle" has been exceeded.	<ul style="list-style-type: none"> refer to E15 	<ul style="list-style-type: none"> refer to E15
E26	Upper limit value in measuring channel "angle 2" has been exceeded.	<ul style="list-style-type: none"> refer to E16 	<ul style="list-style-type: none"> refer to E16
E27	Upper limit value in measuring channel "length telescope I (+II) has been exceeded.	<ul style="list-style-type: none"> refer to E17 	<ul style="list-style-type: none"> refer to E17
E2A	Upper limit value in measuring channel "slewing angle 1" has been exceeded	<ul style="list-style-type: none"> refer to E1A 	<ul style="list-style-type: none"> refer to E1A
	slew above allowed range	<ul style="list-style-type: none"> 1-cannel slew sensor max. value DGA 11.5.8 <> 0 	<ul style="list-style-type: none"> move to allowed slew range
E2B	Upper limit value in measuring channel "slewing angle 2" has been exceeded	<ul style="list-style-type: none"> refer to E1A 	<ul style="list-style-type: none"> refer to E1A
E2C	Upper limit value in measuring channel "luffing jib angle" has been exceeded	<ul style="list-style-type: none"> Angle potentiometer defective Electronic component in the measuring channel defective. 	<ul style="list-style-type: none"> Replace angle sensor Replace sensor unit
E31	Error in the system program	<ul style="list-style-type: none"> The system program file is defective. Flash-EPROM defective 	<ul style="list-style-type: none"> Upload valid system software Replace central unit

Error Code List

Error Code	Error	Cause	Elimination
E32	Error in the power supply	<ul style="list-style-type: none"> +UB System not present at the system start +UB System not present at the system finish Contact problems at +UB switch off/on 	<ul style="list-style-type: none"> +UB System and +UB Power must be wired separately: +UB System connected direct with the crane battery. +UB Power for switch on/off +UB switch off/on again
E37	Error in the logical program flow	<ul style="list-style-type: none"> System program file is defective Flash-EPROM defective 	<ul style="list-style-type: none"> Upload valid system software Replace central unit
E38	System program and crane data file do not match.	<ul style="list-style-type: none"> The system program in the SLI does not match to the programming in the crane data file 	<ul style="list-style-type: none"> Upload valid system program file or the valid crane data file
E39	System program and load chart file do not match	<ul style="list-style-type: none"> The system program in the SLI and the programming in the load chart file do not match. 	<ul style="list-style-type: none"> Upload valid system program file or the valid load chart file
E43	Error in the write/read memory, (RAM)	<ul style="list-style-type: none"> Write/read memory (RAM) or central unit defective. 	<ul style="list-style-type: none"> Replace central unit
E47	Error in the monitored write/ read memory. The CRC verification of the monitored write/read memory provides an incoherent result	<ul style="list-style-type: none"> The CRC sign of the monitored write/read memory is wrong The buffer battery is needs recharged (< 2V at 1kOhm). Central unit defective. 	<ul style="list-style-type: none"> Restart the SLI Replace buffer battery on the central unit. Replace central unit
E51	Error in the crane data file	<ul style="list-style-type: none"> No valid data in the crane data file. Flash-EPROM defective 	<ul style="list-style-type: none"> Upload valid crane data file Replace central unit
E52	Error in load chart file.	<ul style="list-style-type: none"> No valid data in the load chart file Flash-EPROM defective 	<ul style="list-style-type: none"> Upload valid load chart file Replace central unit
E53	Wrong setup of min. analog inputs length1, angle1, pressure1	<ul style="list-style-type: none"> Analog input not supported 	<ul style="list-style-type: none"> Setup correct Flag in DGA 6.i.2
E56	Error in crane data file.	<ul style="list-style-type: none"> No valid data in the crane data file during calibration. Flash-EPROM defective 	<ul style="list-style-type: none"> Restore or upload valid crane data file Replace central unit
E57	Error in serial crane data file.	<ul style="list-style-type: none"> Calibration data file does not contain valid data. Flash-EPROM defective 	<ul style="list-style-type: none"> Upload calibration data file by changing data (OM, limits) and save Replace central unit
E61	Error in the CAN bus data transfer for all CAN units	<ul style="list-style-type: none"> CAN Bus cable between the central unit and the sensor unit defective or not connected. Can bus port in the central unit defective 	<ul style="list-style-type: none"> Check the connection between the central unit and the sensor units Replace the central unit

Error Code List

Error Code	Error	Cause	Elimination
		<ul style="list-style-type: none"> Short circuit in a CAN Bus cable 	<ul style="list-style-type: none"> Replace Can Bus cable
E62	Error in the can bus data transfer of the pressure transducer sensor unit	<ul style="list-style-type: none"> Cable between the central unit and the sensor unit defective. 	<ul style="list-style-type: none"> Check the cable to the sensor unit
		<ul style="list-style-type: none"> Can bus port in the central unit defective 	<ul style="list-style-type: none"> Replace the central unit
		<ul style="list-style-type: none"> Can bus port in the sensor unit is defective 	<ul style="list-style-type: none"> Replace the sensor unit
		<ul style="list-style-type: none"> Sensor unit is defective 	<ul style="list-style-type: none"> Replace the sensor unit
E63	Error in the can bus pressure transducer sensor unit	<ul style="list-style-type: none"> The analog values of the sensor unit are invalid 	<ul style="list-style-type: none"> Replace the sensor unit
E64	Error in the can bus data transfer of the length/angle sensor unit	<ul style="list-style-type: none"> See E62 	<ul style="list-style-type: none"> See E62
E65	Error in the can bus length/angle sensor unit	<ul style="list-style-type: none"> See E63 	<ul style="list-style-type: none"> See E63
E66	Error in the data of the digital I/O MENTOR	<ul style="list-style-type: none"> PDB variable invalid 	<ul style="list-style-type: none"> Change system software Change MENTOR
E67	Error in the can bus data transfer of the digital I/O external module	<ul style="list-style-type: none"> PDB variable invalid 	<ul style="list-style-type: none"> Connect digital I/O external CAN module
E68	Error in the can bus data transfer of the force sensor unit	<ul style="list-style-type: none"> See E62 	<ul style="list-style-type: none"> See E62
E69	Error in the can bus force sensor unit	<ul style="list-style-type: none"> See E63 	<ul style="list-style-type: none"> See E63
E84	Wrong rigging condition.	<ul style="list-style-type: none"> The selected rigging condition is not contained in the crane data file. 	<ul style="list-style-type: none"> Select another rigging condition Check the programming in the crane data file.
E85	Error in the radius determination	<ul style="list-style-type: none"> The computed radius is too small (negative deflection) 	<ul style="list-style-type: none"> Check the programming in the crane data file.
E89	Operating mode switchover with load.	<ul style="list-style-type: none"> The operating mode on the console has been switched over with the boom loaded. 	<ul style="list-style-type: none"> Select operating mode without load on the boom
E98	SLI watchdog activated	<ul style="list-style-type: none"> SLI processing time limit exceeded 	<ul style="list-style-type: none"> Reset system Connect PC terminal and watch error messages
EAB	Short circuit in the A2B switch circuit (not with radio A2B)	<ul style="list-style-type: none"> Short circuit in the A2B switch 	<ul style="list-style-type: none"> Replace A2B switch
		<ul style="list-style-type: none"> Short circuit in the cable to the A2B switch 	<ul style="list-style-type: none"> Replace cable to the A2B switch
EAC	A2B switch circuit disconnected (not with radio A2B)	<ul style="list-style-type: none"> Disconnected cable in the A2B switch 	<ul style="list-style-type: none"> Connect or replace cable in the A2B switch
		<ul style="list-style-type: none"> Disconnected cable to the A2B switch 	<ul style="list-style-type: none"> Connect or replace cable to the A2B switch

Error Code List

Error Code	Error	Cause	Elimination
EAD	No valid A2B switch status	<ul style="list-style-type: none"> • Sensor wrong function • CAN bus delay • Radio telegram delay module (radio A2B) • Radio telegram ID is invalid 	<ul style="list-style-type: none"> • Replace A2B switch • Replace cable to the A2B switch • Replace battery of radio module (radio A2B) • Setup ID in DGA12.9
EDB	Datalogger setup error	<ul style="list-style-type: none"> • Setup of the datalogger is cleared (ser. crane data file or battery buffered RAM) 	<ul style="list-style-type: none"> • transfer data and setup datalogger again
EDC	Datalogger watchdog activated	<ul style="list-style-type: none"> • datalogger processing time limit exceeded 	<ul style="list-style-type: none"> • Reset system • Connect PC terminal and watch error messages
EDD	Battery empty	<ul style="list-style-type: none"> • Battery check detected a low voltage of the battery 	<ul style="list-style-type: none"> • change batteries, after this setup of RTC
EDE	Record lost	<ul style="list-style-type: none"> • Not possible to save data because other task saves data at the same time 	<ul style="list-style-type: none"> • Message disappears after a few seconds
EDF	Flash block full	<ul style="list-style-type: none"> • Not possible to save any more data 	<ul style="list-style-type: none"> • Message disappears after a few seconds
EFD	SLI Watchdog extra time	<ul style="list-style-type: none"> • a function needs more than 0.5 sec, e.g. Flash PROM write 	<ul style="list-style-type: none"> • Message disappears after a few seconds

NOTE:

If an error message not included in the above list is displayed, please contact Hirschmann Service USA:
www.hirschmann.com > USA > Electronic Control Systems > Contact - ECS.

Revision History

Rev.	Date	Changes	Name
Rev. A	2008-07-11	First edition for National 1300H System software SQG2 V d3.09 SLI software LSQN V 1.xx Graphics National V 1.04 Application National MQVGA V 1.04 (20080619)	Konopka
Rev. B	2009-05-05	Revision B for National Cranes modified menu graphics, layout correction System software SQG2 V 3.14 SLI software LSQN V 1.12 Graphics National V 1.05 (20081218) Application National MQVGA V 1.05 (20081218)	Konopka
Rev. C	2009-07-02	Revision C for National Cranes Modified max. load description, SLI to LMI change Spare parts listings added	Ellis
Rev. D	2011-08-10	Revision D Changed cable reel picture and parts list Made grammatical changes ECN 11-169	Gase