

PAT

IK 350 / 1368

Operator's Console for FA 035 /ATF110G-5



Contents

General Information

1

Important Notes

2

System Description

3

Programming

4

Checks before start-up

5

Service and Maintenance

6

Troubleshooting

7

Appendix

Operator's Manual

Issue 10/2007 Rev. D

This document has the order no.
50 350 19 1368 e (ATF 110)

TABLE OF CONTENTS

1. General information	3
2. Important notes	4
3. System description	5
3.1 System functions	7
3.2 Control console	7
3.3 Indicators and control elements	8
3.4 Data display (normal operation)	16
3.4.1 Description of status symbols	17
3.4.2 Switch over for multi function field	17
3.5 Data display (illustration for counterweight assembly)	18
3.6 Data display (telescoping and bolting display)	19
4. Programming	20
4.1 Programming the required mode	21
4.2 Setting the rope fall arrangement	23
4.3 Contrast setting, data display	25
4.4 Language selection	26
4.5 Speed preselection for master controller	27
4.6 Limitations of geometry	28
4.6.1 Limitation of the slewing angle	29
4.6.2 Limitation of the boom head height	30
4.6.3 Limitation of the boom angle	31
4.6.4 Limitation of radius	32
5. Checks before start-up	33
5.1 Operation	35
6. Service and maintenance	36
6.1 Info menu	37
6.2 Service menu	38
7. Troubleshooting	39
7.1 General information	39
7.2 Error messages (E ##)	39
7.3 Error messages (S2/S3)	44
7.4 Error messages (S2)	45
Appendix	46

1. GENERAL INFORMATION

The PAT Load Moment Indicator (LMI) and control system iFLEX5 has been designed to provide the crane operator with the essential information required to enable the machine to be used within its design parameters. Using various sensing devices, the Load Moment Indicator monitors various crane functions and provides the operator with a continuous reading of the crane's capacity. The readings continuously change as the crane moves through the motions needed to make the lift.

If non permitted conditions are approached, the Load Moment Indicator will warn the operator by sounding an audible alarm, lighting a warning light and locking out those functions that may aggravate the crane's condition.

The PAT iFLEX5 system provides a graphical user surface whose functionality and layout is determined by the crane manufacturer. The selection of the programmed functions is essentially simplified by the use of symbols.

The Load Moment Indicator and Control system consists of an iFLEX5 system consisting of two units, an operator's console IK 1368 CAN and different sensors for the acquisition of measuring values.

The manufacturer reserves the right to modify the contents of this manual without notice. Hirschmann offers no guarantee whatsoever for this material, including guarantees with reference to commercial availability and suitability for particular applications. Hirschmann shall not be liable for errors contained herein or for identical or consequential damages in connection with the furnishing, performance, or use of this manual. This manual is protected by copyright. All rights reserved. The manual may not be copied, reproduced or translated into another language, neither whole nor in part, without advance written authorization from Hirschmann.

2. IMPORTANT NOTES

The LMI is an operating aid to warn the crane operator of an imminent overload or proximity of the hook block to the boom head, in order to avoid possible damage to property or personal injury.

The system cannot be, and is not intended to be, a substitute for good judgement or experience on the part of the crane operator, or for the application of recognised, safe working methods when using cranes.

 **ATTENTION**

The crane operator is not released from his obligation to operate the crane safely. He must ensure that he fully understands and follows the notes and instructions displayed.

Before beginning work with the crane, the crane operator must carefully read and understand the entire Manual to ensure that he is aware of the operation and limitations of the LMI.

Proper functioning depends on due daily inspection and compliance with the operating instructions listed in this Manual. Please read section 5 of this Manual.

 **WARNING**

The LMI can only offer the crane operator help if it is correctly adjusted, and the correct load chart and the correct operating code have been selected for the particular rig arrangement. To avoid damage to property and serious or even fatal injuries to persons, it is essential to ensure that the LMI is correctly adjusted before beginning crane work.

 **WARNING**

This system can be equipped with an external key-operated switch which is located on the side of the housing of the central unit. This key-actuated switch bridges (overrides) the control lever's shut-off function by the LMI. This switch may only be actuated in emergencies by authorized personnel. Non-compliance with these instructions may lead to damage to property and serious or even fatal injuries to persons.

System description

3. SYSTEM DESCRIPTION

The Load Moment Indicator and Control system for the FA 035 / ATF110G-5 consists of an iFLEX5 system consisting of two central units, an operator's console IK 1368 CAN and different sensors for the acquisition of measuring values.

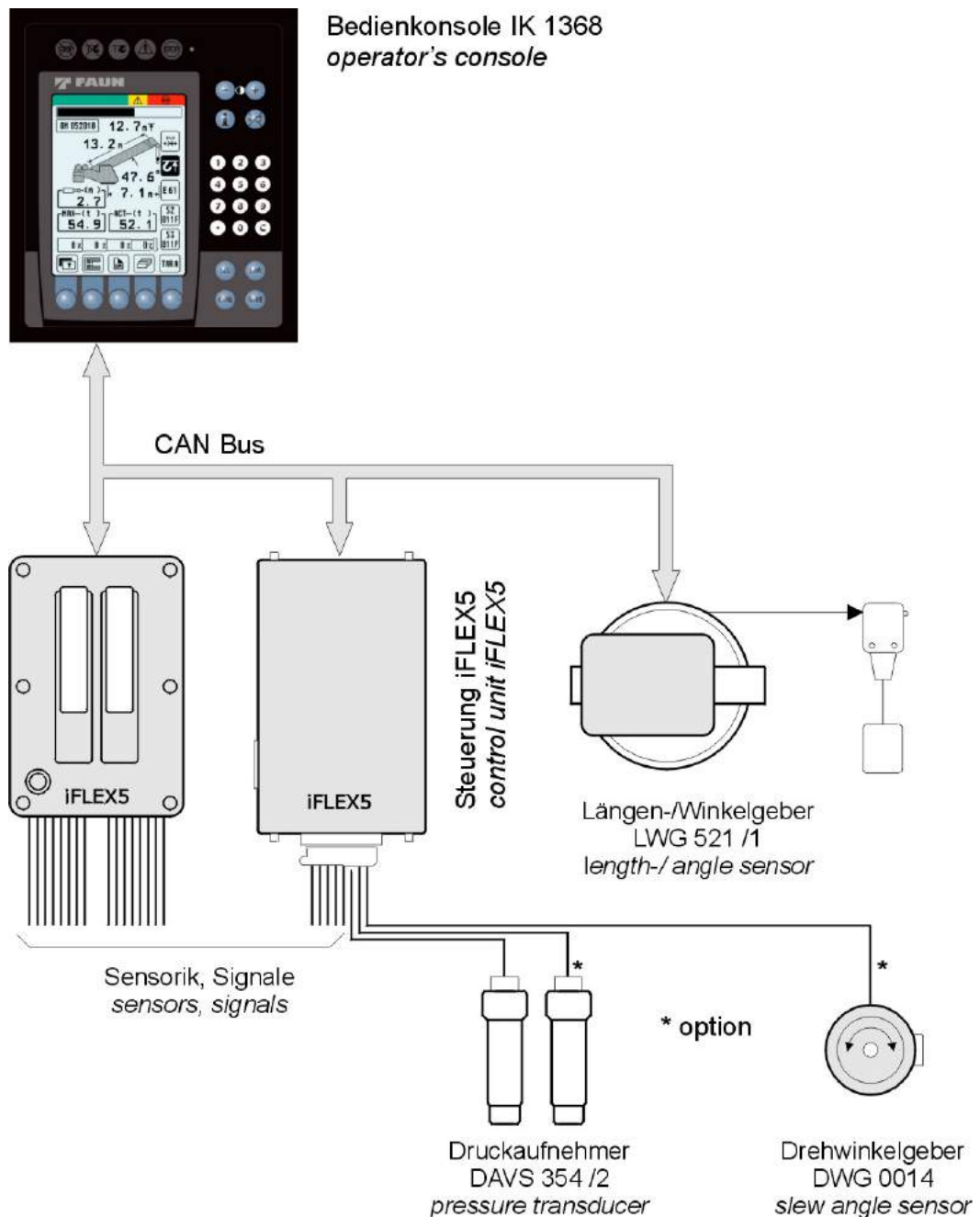

System description

The system works according to the principle of variance comparison. The actual value which is obtained by pressure measurement, is compared with the set values stored in the central data memory, and evaluated by the microprocessor. When the limit values are reached, an overload warning signal is triggered on the display and control console. At the same time, any crane movements that could increase the load are disabled.

The crane-related data specified by the manufacture, such as load charts, boom weights, centres of gravity and dimensions, are stored in memory chips in the central data memory. These data form the reference values for calculating the operating states.

In some cases, the system function is controlled by automatic components such as boom length and angle transmitters, and in other cases by manual devices, such as keys on the display and control console.

The boom angle and the boom length are detected by a length-angle transmitter mounted on the boom. The crane load is measured using pressure sensors mounted on the piston and rod sides of the boom elevation cylinder.

System description

3.1 System functions

After the system is switched ON, it starts with an automatic test run of the LMI system, the displays and control elements as well as of the acoustic alarm.

During the test run, the start screen is displayed:



- After the system has passed through the system test without errors, the crane data display appears.

In case of malfunction, an appropriate error code "E##" appears on the *data display* (1). (In this context, refer also to chapter 7.)

3.2 Control console

The console has two functions:

- Inputs into the LMI system by the crane operator (operation modes, numbers of rope falls)
- Indication of important data and information
- Information for service purpose

The control console is located in the crane cabin in the crane operator's field of vision. To improve identification of the displays and control elements, these are backlit during operation. The console comprises various control elements as well as a multifunctional LC display; these are described in detail in chapter 3.3

Operation

3.3 Indicators and control elements

Fig. 1 shows the indicator and control elements of the DS 350 /1368 console. The numbers in the figure correspond to the numbers in the following functional description for each element.

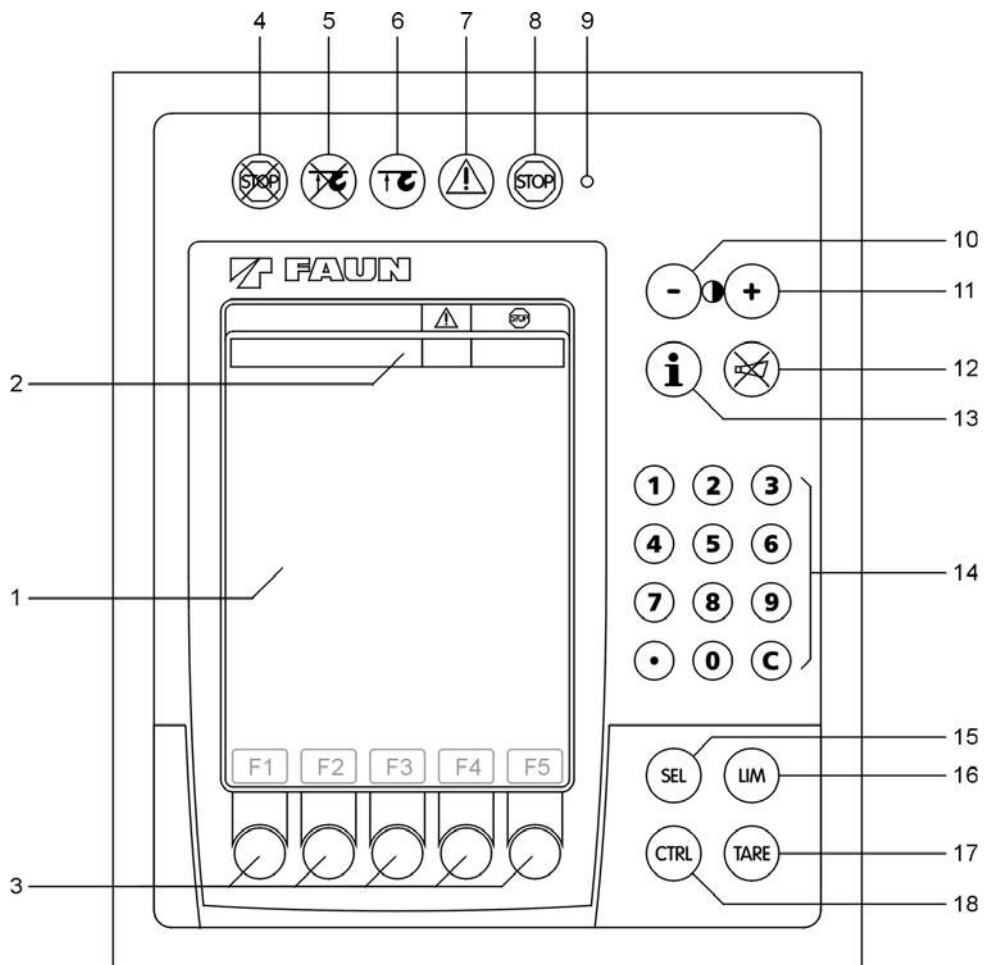

Fig. 1

- | | | | |
|---|---------------------------------|----|---------------------------------|
| 1 | Data display | 10 | "increase contrast" tip switch |
| 2 | Utilization indicator (bargraf) | 11 | "decrease contrast" tip switch |
| 3 | Function keys F1...F5 | 12 | "Alarm off" tip switch |
| 4 | "LMI override" warning lamp | 13 | "Information" tip switch |
| 5 | "A2B override" warning lamp | 14 | Numerical keypad |
| 6 | "A2B " warning lamp | 15 | "Operation mode" tip switch |
| 7 | Pre-warning lamp (load moment) | 16 | "Geometrical limits" tip switch |
| 8 | Overload lamp (load moment) | 17 | "Tara" tip switch |
| 9 | Contrast sensor | 18 | special functions tip switch |

Operation

(1) Data display

The *data display* (1) is a backlit graphic LC display which shows, depending on the operating state, the required information, such as load values, geometric and crane data, symbols etc. During night work, the indication appears inverted to prevent dazzling the crane operator.

Examples for possible indications:

Set-up menu (operation mode)

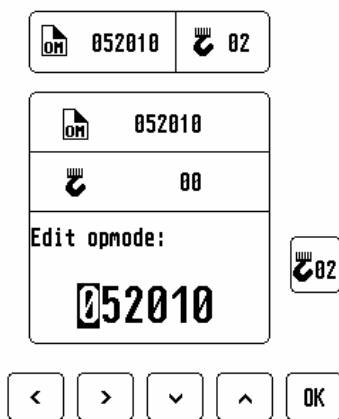

Normal operation display

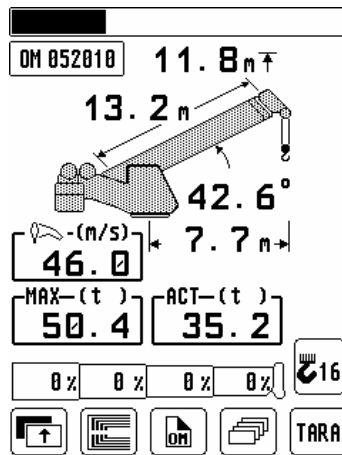

Programming slewing angle

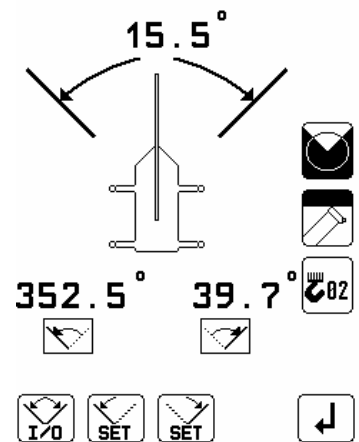

Service menu analog inputs II

NODE2

BASIC		EXTENTION	
AI		AI	
0	34 33.3	0	34
1	35 -107.	1	35
2	36 -40.8	2	36
3	37 -104.	3	37
4	38 76.9	4	38
5	39	5	39
6	40	6	40
7	41	7	41

DIG IN DIG OUT ANA OUT

Tele control indicator

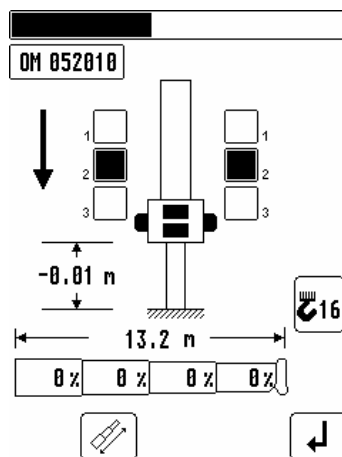

Contrast setting menu

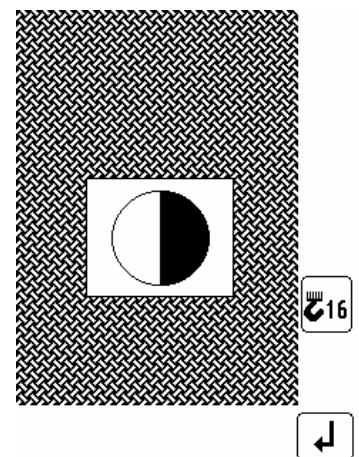

A detailed description of the symbols and indicators is given in chapters 3.4, 3.5, 3.6 and 6. of this manual.

Operation

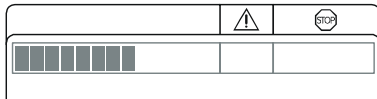
(2) Utilization bar graph

This utilization bar graph display indicates how much of the loader's rated capacity is being used. (utilization)

As the rated capacity of the loader changes as it is moved through its various motions, the utilization display will constantly change as well.

The bar graph is marked with different colors:

- green: and safe section (0%...90% of rated cap.)
- yellow: prewarning section (90%...100% of rated cap.)
- red: overload section (>100% of safe working load)

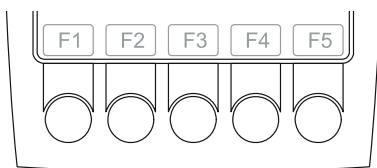
(3) Function keys F1...F5

These keys can be used to select certain functions from among menu symbols with selection options. The symbols above the keys identify the function in question.

The meaning of the various symbols is shown in chapters 3.4 to 3.6 and in chapter 6.

(4) "LMI override" warning lamp

This red warning lamp goes on if the LMI shut-off feature has been bridged manually.

(5) "Anti-Two Block switch (A2B) override" warning lamp

This red warning lamp goes on if the hoist limit switch shut-off feature has been bridged manually.

Operation

(6) "A2B" warning lamp



This red warning lamp goes on if the contacts of the hoist limit switch open, i.e. a hoist limit state has occurred. The acoustical alarm sounds, while crane movements increasing the load moment are stopped.

NOTE

A hoist limit state occurs if the hook block touches the boom head. In this case, there is a risk of the winch rope breaking and the load falling. The cause of the hoist limit state may be that the load has been drawn against the boom head or that the boom has been extended or lowered without the corresponding length of winch rope having been unwound.

(7) "Pre-warning load moment" warning lamp



This yellow pre-warning lamp goes on if the load of the crane amounts to more than 90 % of the rated lifting capacity in question, thus indicating an imminent overload situation.

(The warning light will **flash**, if the upper main boom angle limit is exceeded (if operation mode is "on rubbers")

 **ATTENTION**

This means that the crane operator is only allowed to continue crane work with extreme caution!

Operation

(8) "Overload" warning lamp



This *red overload warning lamp* informs the crane operator that an overload condition has occurred.

It goes on when the load imposed on the crane has reached 100 % of the maximum lifting capacity which is admissible for the current operating state. The acoustical alarm will sound. At the same time, the crane movements increasing the load moment are stopped.

(9) Sensor "display contrast"



Dependent to the surrounding light conditions this sensor controls the brightness of the LC display and the buttons.

(10-11) "Contrast setting" tip switches

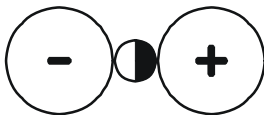

With this buttons the display contrast can be adjusted according to the environmental light conditions. By pressing both buttons simultaneously the preset contrast is set. The contrast setting also can set via the contrast setting menu (chapter 4.3)

(12) "Horn off" key

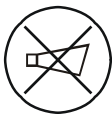

Operation of this push-button serves to briefly suppress the acoustical alarm (soonest after 5 s alarm duration). The alarm sounds again, if the reason for which the alarm has been triggered is still present.

(13) "Info" key



This key selects system information menu (refer to chapter 6.1)

Operation

(14) Numerical keypad



These numerical keys are used for numerical inputs.



The keys  and  have no function !



(15) "Select" key (SEL)



The key "SEL" is used to call up the set-up menu for setting the mode codes, the number of rope. Upon actuation, the *hoist limit switch warning lamp* (7) and the *overload warning lamp* (8) go on, and the LMI shut-off feature is activated.



The correct setting of the LMI for the rig arrangement in question is extremely important for correct functioning of the system and the crane. Thus, mode codes and the number of rope falls may only be set by crane operators who are absolutely familiar with load charts, utilization and operation of the system.

The procedure for entering the mode code, the number of rope falls and the speed preselection for the master controllers is described in chapter 4.

Operation

(16) "Limits" key (LIM)



Key used to program limitations of geometry.
(refer to chapter 4.5)

(17) "Tare" key (TARE)



The "TARE" key serves to issue the net load to the *actual load indicator "ACT"* (refer to chapter 3.4). The net load is the actual load less load lifting equipment and hook block. The "TARE" key must be pushed **before** hoisting operation is commenced.

After the key has been actuated, it lights up and the actual load indication is set to zero (tared). After the load has been lifted, the net load (payload) appears in the actual load indicator.

As soon as the working radius is changed (due to changes of the angle or radius), the indicator displays again the actual load, and the taring function is finished.

NOTE

The actual load comprises the hook block, the winch rope and all load handling devices. The net load is the load currently fixed to the hook, without load handling device. Incorrect indications may be due to ambient influences, e.g. the wind acting on a boom or the load.

(18) "Control" key (CTRL)



The "CTRL" key serves to select the special functions. The following special functions can be selected:

- Display contrast setting (*see chapter 4.3*).

Operation

Acoustical alarm (without illustration)

The acoustical alarm sounds in the following cases:

System test, overload condition, approaching a hoist limit state (if hoist limit switch function is detected by the LMI), malfunction of LMI system, and in case of operating errors detected by the system.

The acoustical alarm can be suppressed briefly via the key (12) "*Alarm switch*" soonest after 5 s alarm duration. The alarm sounds again, if the reason for which the alarm has been triggered is still present.





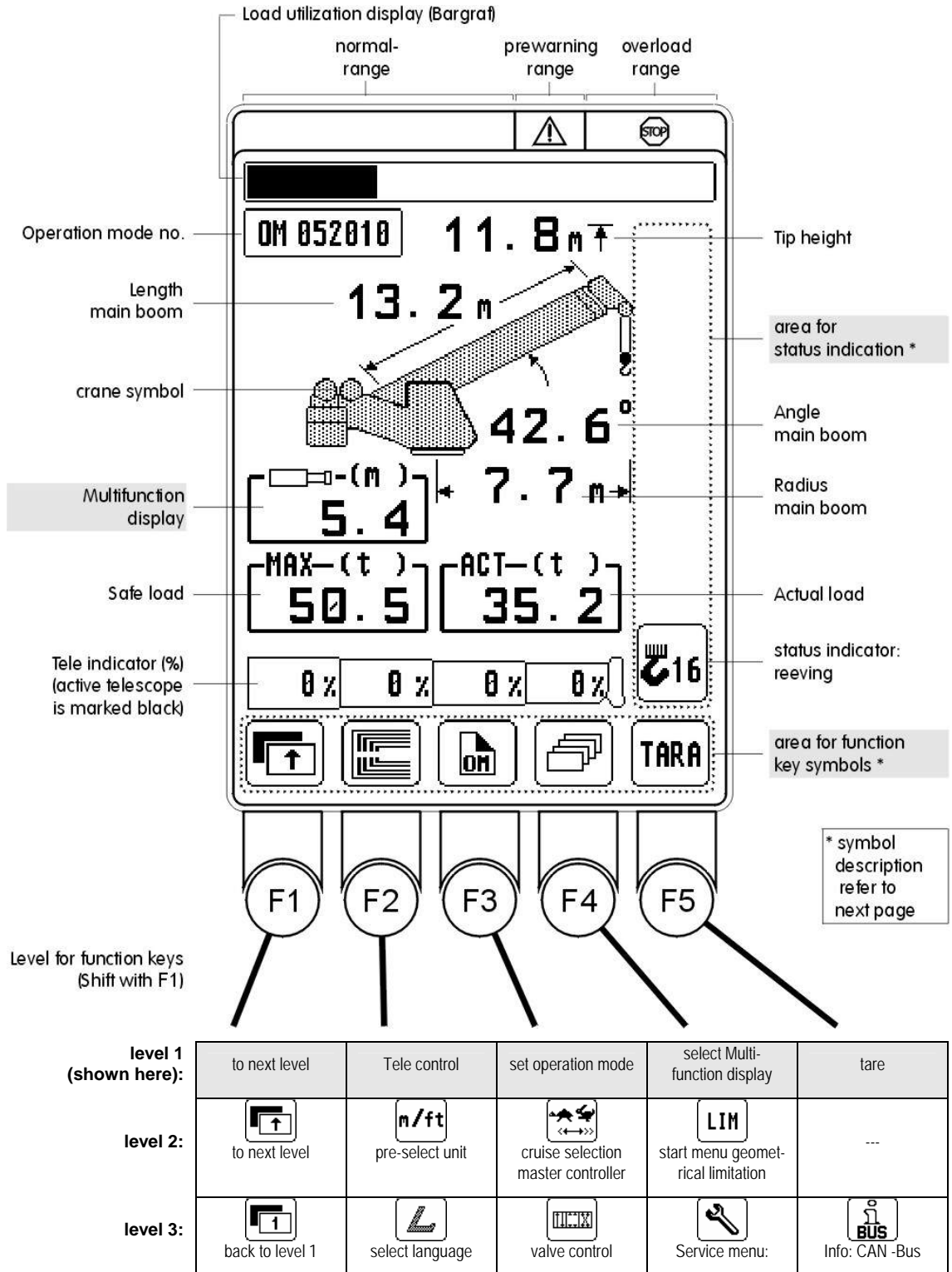













Operation

3.4 Data display (normal operation)



Operation

3.4.1 Description of status symbols

	auxiliary winch selected		tele correction
	LMI error		tele stop
	control error node 2		tele position reached
	control error node 3		slewing angle limitation active
	bus error		height limitation active
	slewing brake		radius limitation active
	reeving		boom angle limitation active
	Anti two block switch		upper structure locked
	ID-sensor error		speed preselect active
	locking sensor error		

3.4.2 Switch-over for multi-function field

With function key  (first level) the content of the multi-function field can be scrolled:

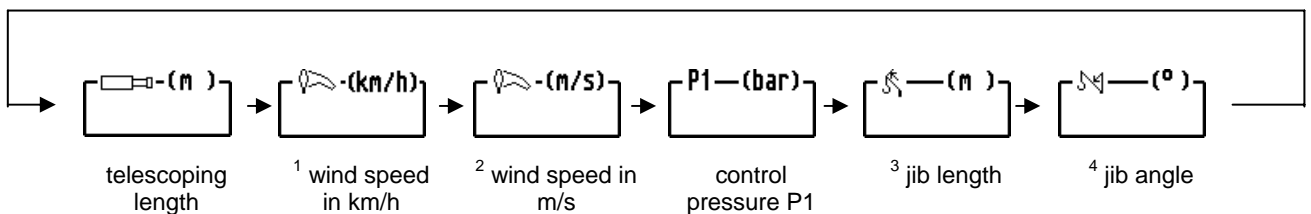

¹ only with corresponding software configuration, otherwise step will jumped over
² appears automatically, if the pre-programmed wind speed limit is exceeded. The value flashes and the alarm sounds simultaneously.
³ only with existing jib extension, otherwise step will jumped over
⁴ only with existing jib extension, otherwise step will jumped over

Operation

3.5 Data display (illustration for counterweight assembly)

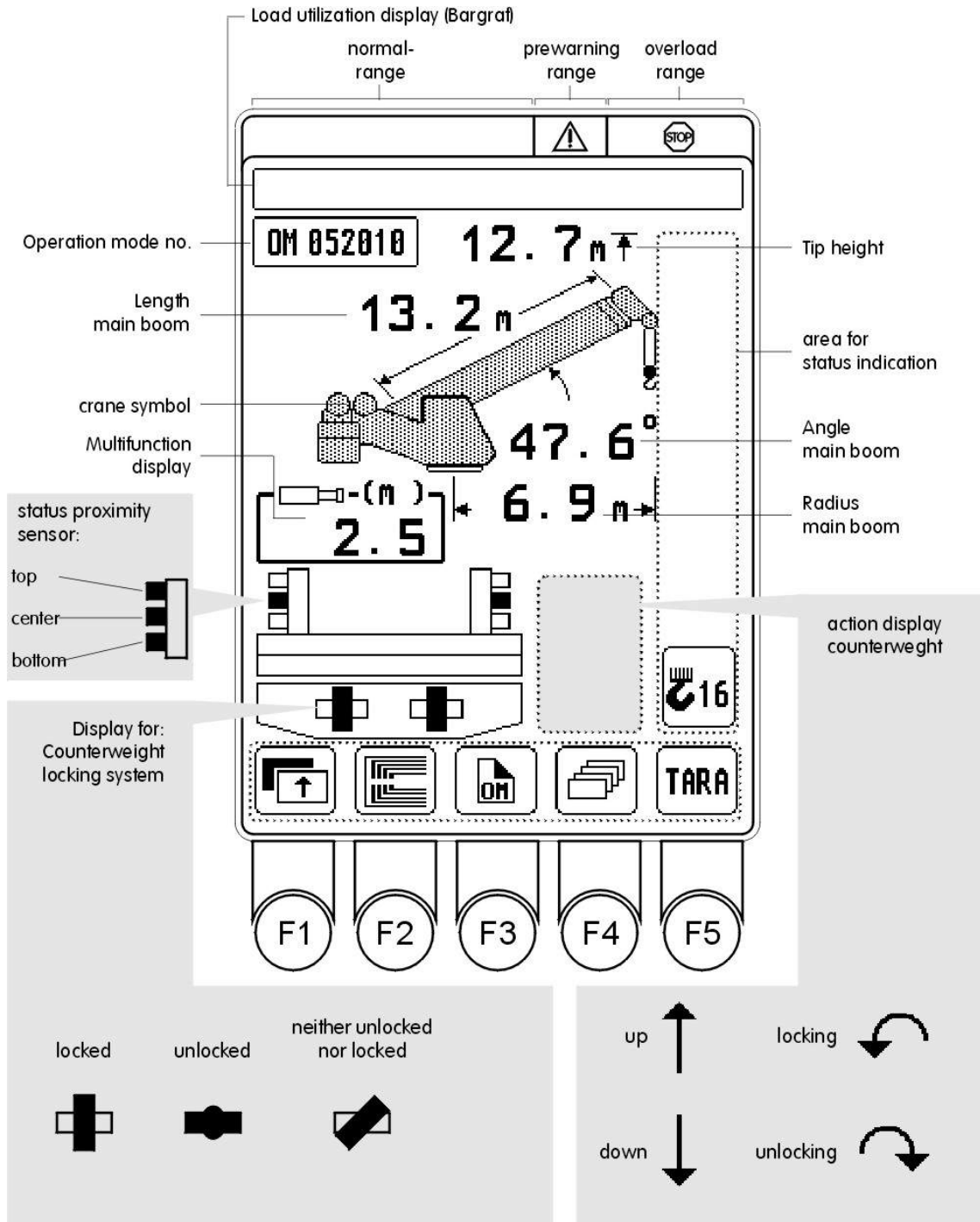

Operation

3.6 Data display (telescoping and bolting display)

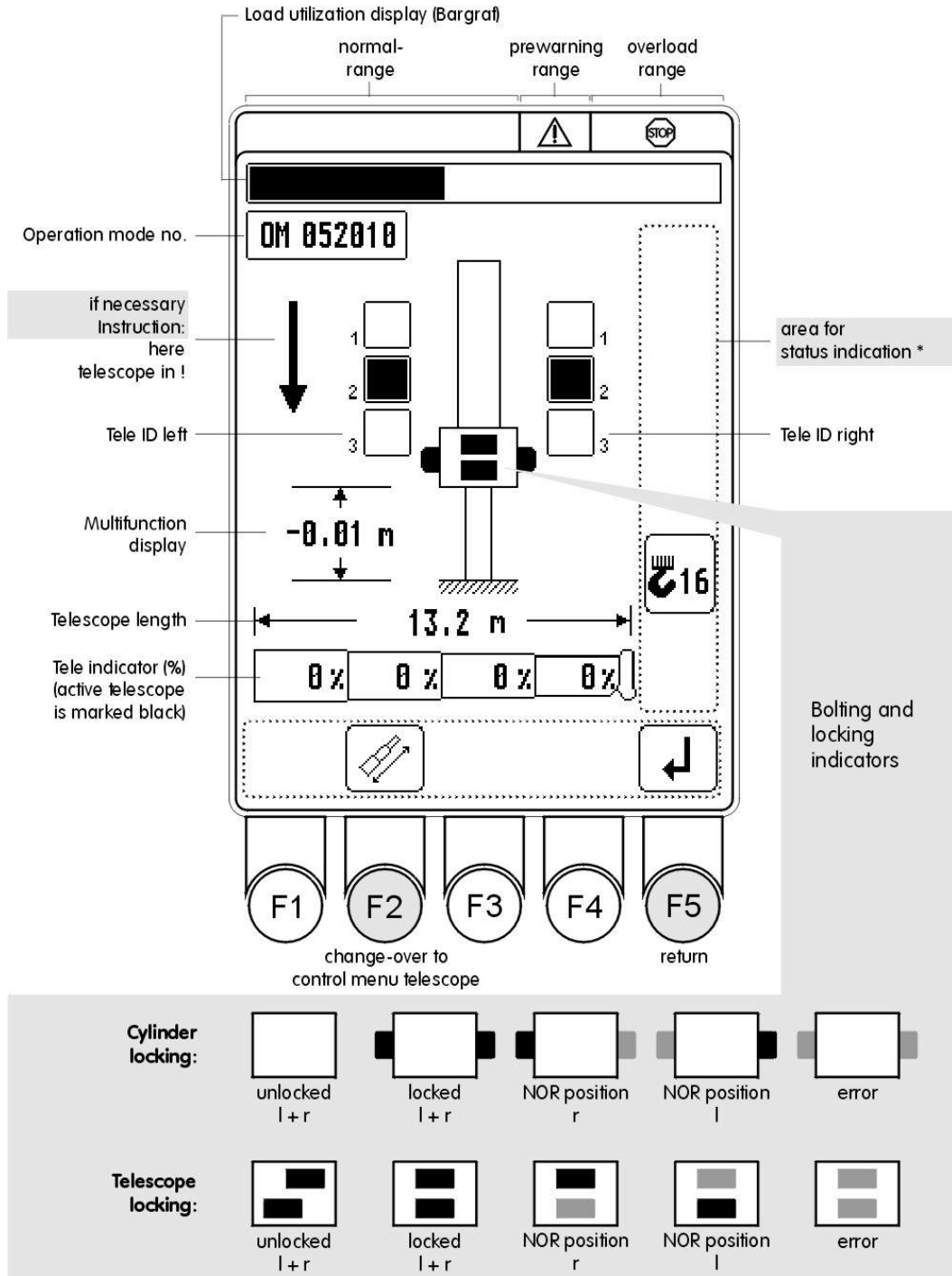

Programming

4. PROGRAMMING

After switching ON the system, the operating parameters must first be entered according to the actual rig arrangement of the crane. Here, it is essential that the crane operator's entries are made correctly!

This procedure consists of two parts:

- Programming the LMI according to the crane's rig arrangement, using the correct operating code for the selected load chart (*refer to chapter 4.1*).
- Input of the rope fall arrangement (rope reeving) according to the actual number of rope falls used (*refer to chapter 4.2*).



Wrong input into the LMI of the operating code and the number of rope falls used can result in material damage and/or in serious, even fatal injury to persons.

The correct input of the operating code and the number of rope falls is essential for proper functioning of the system and the crane.



Consequently, these entries may only be performed by crane operators who are absolutely familiar with load charts and the application and control of the LMI.

Programming

4.1 Programming the required mode

Any modification of the crane structure requires a setup of the LMI system by input of a corresponding operation mode code. The setup procedure can **only** be started during normal operation display.

During the programming procedure, the system interrupts crane movements temporarily. Moreover, the warning lamps (7) and (8) go on.

Call of function: By actuating key  or with function key 

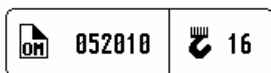

Enter operation code

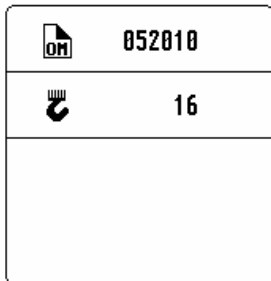

return to normal display

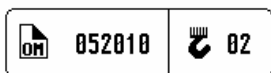

Cursor automatically moves to the first digit. The input can be carried out via numerical keypad (14) or with function keys.



Set cursor to the left by one digit



Set cursor to the right by one digit



decrease marked value



increase marked value



Confirm input



When changing the operation mode, the succeeding acknowledgement menu is displayed

Programming

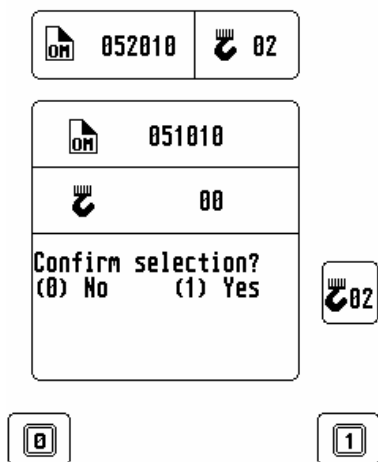

In this menu the operator has to confirm the inputs again.

Check indicated inputs before confirmation !



NO, inputs are invalid.



YES, inputs are valid



After confirmation the input of the operation mode is terminated and the normal display appears.

Programming

4.2 Setting the rope fall arrangement

Any modification of the number of falls (reevings) requires a setup of the LMI system by input of a corresponding reeving number. The setup procedure can **only** be started during normal operation display.

During the programming procedure, the system interrupts crane movements temporarily. Moreover, the warning lamps (7) and (8) go on.

Call of function: By actuating key  or with function key 

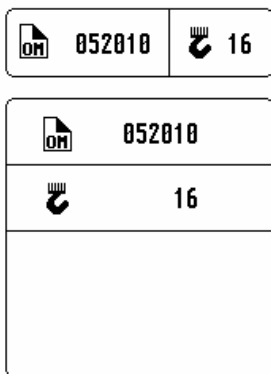

input reeving



return no normal display

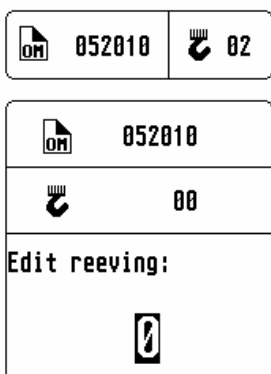

Cursor automatically moves to the first digit. The input can be carried out via numerical keypad (14) or with function keys.



Set cursor to the left by one digit



Set cursor to the right by one digit



decrease marked value



increase marked value



Finish input



When changing the operation mode, the succeeding acknowledgement menu is displayed:

Programming

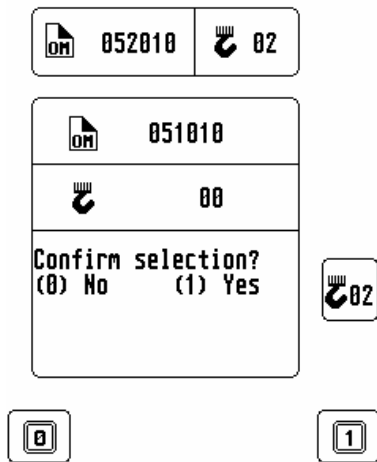

In this menu the operator has to confirm the inputs again.

Check indicated reeving number before confirmation !



NO, inputs are invalid.

YES, inputs are valid

After confirmation the input of the reeving is terminated and the normal display appears.

Programming

4.3 Contrast setting, data display

This function can be used to adjust the display contrast optimally according to the light conditions. The setting remains stored and thus need not be performed every time the system is started up.



Actuate "CTRL" key.

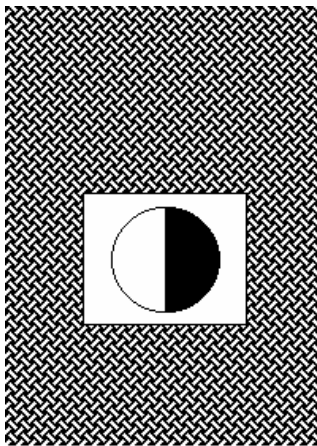

A pattern enabling optimum contrast tuning appears on the display. If necessary, set contrast via the function keys as follows:



Actuate the  key to save the settings and to terminate the function.

Note: The contrast directly can be adjusted via key (10) and (11)

Programming

4.4 Select language

The system features a function which allows language selection for the display menus. The following languages are selectable: german, english

Call function: by actuating key  (normal display, layer 3)

Select language



-  **FÜR DEUTSCH**
-  **FOR ENGLISH**
-  **VOOR NEDERLANDS**
-  **POUR FRANCAIS**

Select desired language with function buttons.

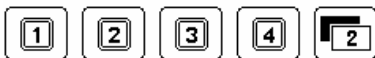
By pressing function button F5 you can switch over the display layer to select other available languages.



Select language



-  **PARA ESPANOL**
-  **PER ITALIANO**
-  **FOR RUSSIAN**



Programming





4.5 Speed preselection for master controller

By actuating the function key  (normal display, layer 2) the speed preselection menu for the master controllers is called up:

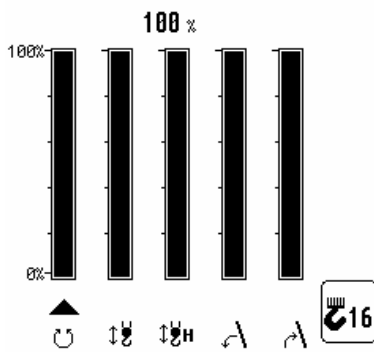
-  speed preselection for main hoist
-  speed preselection for auxiliary hoist
-  speed preselection for luffing cylinder (luffing up and down)

During the programming procedure, the system interrupts crane movements temporarily. Moreover, the warning lamps (7) and (8) go on. If a value was changed, the following symbol appears on the operating menu screen: .





-  Activate bar to the right of the one being edited.
-  Increase marked value by 1 %.
-  Decrease marked value by 1 %.
-  Switch over to quick setting option*
-  Confirm input.



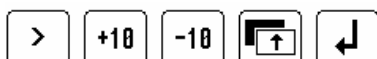

* actuate 1x:

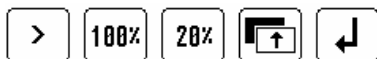

-  Increase marked value by 10 %.
-  Decrease marked value by 10 %.

* actuate 2x:









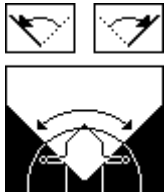

-  set marked value to 100%
-  set marked value to 20%

Programming

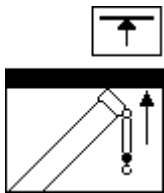
4.6 Limitations of geometry

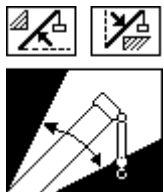
- The LMI system comprises programmed limit entries for the operating range of the crane. Programming easily is facilitated by interactive step-by-step guidance.
- The functions can be used individually or combined. Symbols will mark active limitations.
- If a programmed limit is exceeded,
 - ⇒ the system shuts off the crane moving, which was caused by exceeding the limit.
 - ⇒ this triggers visual indication (blinking symbol)

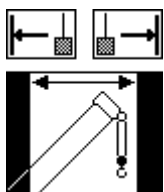
The types of limitation are indicated by the following symbols:

type of limit	overview symbol (with indication of active limits)	status symbols <i>continuous display: limit active</i> <i>blinking display: limit exceeded</i>
Slewing angle limitation		 (⇒ refer to chapter 4.6.1)
Height limitation		 (⇒ refer to chapter 4.6.2)
Boom angle limitation		 (⇒ refer to chapter 4.6.3)
Radius limitation		 (⇒ refer to chapter 4.6.4)

Programming

4.6.1 Limitation of the slewing angle

Programmable function for limitation of the left and/or right slewing angle.

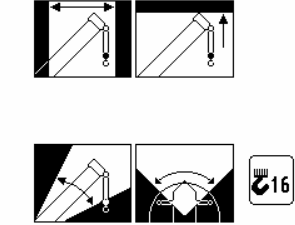
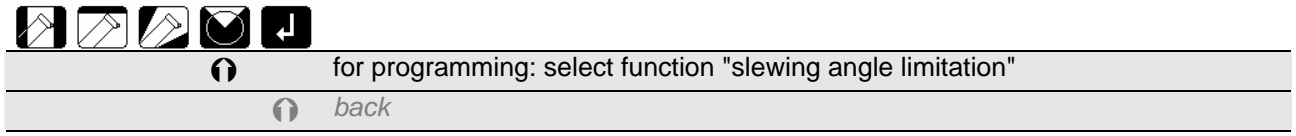

Actuate LMI key. Overview screen appears.

for programming: select function "slewing angle limitation"
back

Store actual slewing angle position as **left** limit.
Store actual slewing angle position as **right** limit.
back

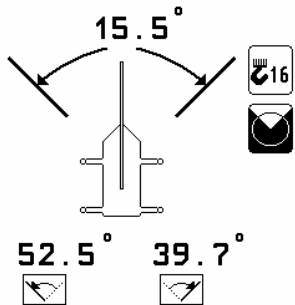
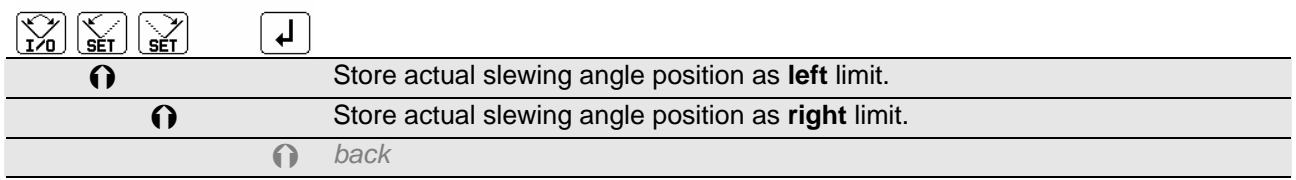

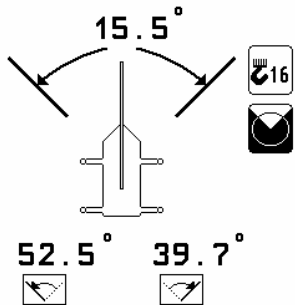
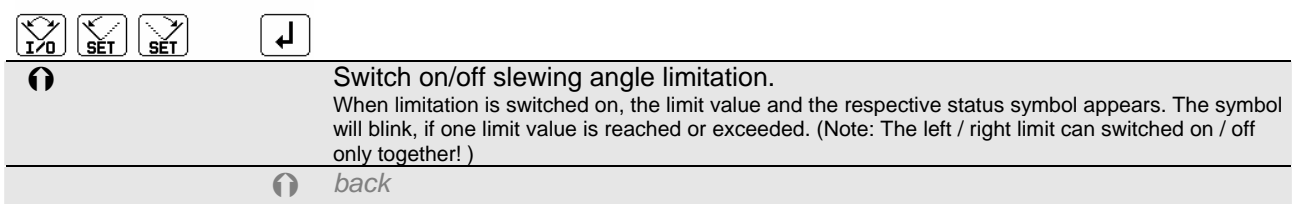

Switch on/off slewing angle limitation.
When limitation is switched on, the limit value and the respective status symbol appears. The symbol will blink, if one limit value is reached or exceeded. (Note: The left / right limit can switched on / off only together!)
back

Programming

4.6.2 Limitation of the boom head height

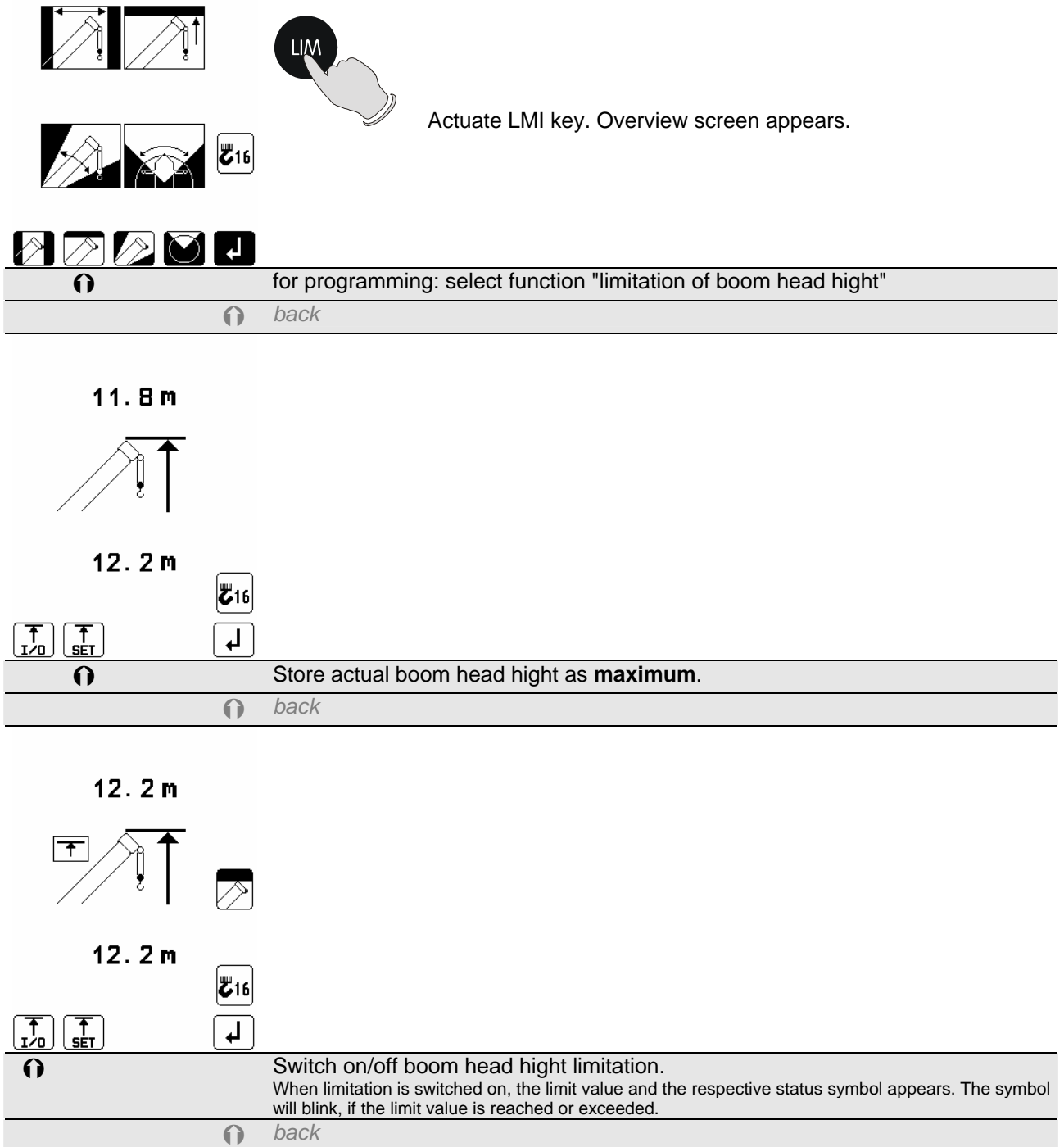
Programmed function for limitation of the boom head height.



Actuate LMI key. Overview screen appears.

11.8 m

12.2 m

for programming: select function "limitation of boom head high"

back

Store actual boom head high as **maximum**.

back

12.2 m

12.2 m

Switch on/off boom head height limitation.
When limitation is switched on, the limit value and the respective status symbol appears. The symbol will blink, if the limit value is reached or exceeded.

back

Programming



4.6.3 Limitation of boom angle



Programmable function to limit the smallest and/or the biggest boom radius.

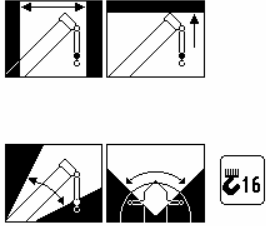
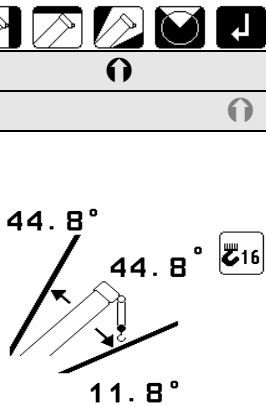
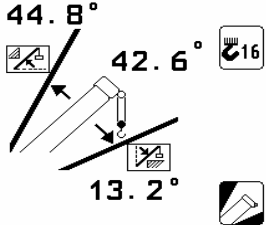



Actuate LMI key. Overview screen appears.

	for programming: select function "limitation of boom angle"
	<i>back</i>

	Store actual boom angle position as maximum limit.
	Store actual boom angle position as minimum limit.
	<i>back</i>

	Switch on/off maximum boom angle limitation. When limitation is switched on, the limit value and the respective status symbol appears. The symbol will blink, if one limit value is reached or exceeded.
	Switch on/off minimum boom angle limitation. When limitation is switched on, the limit value and the respective status symbol appears. The symbol will blink, if one limit value is reached or exceeded.
	<i>back</i>

Programming

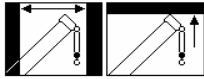

4.6.4 Limitation of radius

Programmable function to limit the smallest and/or the biggest boom radius.

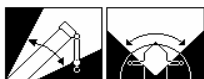

Actuate LMI key. Overview screen appears.



 for programming: select function "limitation of boom radius"
 *back*

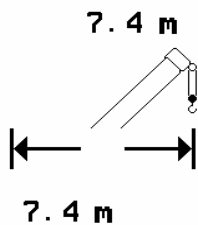



7.4 m

7.4 m

7.7 m



 Store actual boom radius as **minimum** limit.
 Store actual boom radius as **maximum** limit.
 *back*

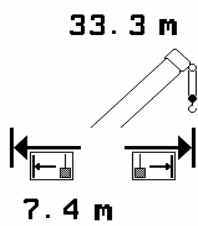



33.3 m

7.4 m

35.2 m



 Switch on/off minimum boom radius limitation.
When limitation is switched on, the limit value and the respective status symbol appears. The symbol will blink, if one limit value is reached or exceeded.
 Switch on/off maximum boom radius limitation.
When limitation is switched on, the limit value and the respective status symbol appears. The symbol will blink, if one limit value is reached or exceeded.
 *back*

Checks before start-up

5. CHECKS BEFORE START-UP

Before crane work is commenced, the following electrical connections must be checked to ensure that the LMI system is correctly wired for the current crane rig arrangement.

- **Cranes with main hoisting gear only**

If the crane is working with the main boom, i.e. without boom extension or fly jib, no additional connections are required. However, it is important to ensure that the hoist limit switch weight is correctly mounted on the main boom winch rope. With an even number of rope falls, the hoist limit switch weight is mounted at the "dead end" of the winch rope. With an odd number of rope falls, the hoist limit switch weight is mounted at the rope fall with the lowest working speed.

If the crane is working with a main boom extension or fly jib, the connecting cable must be installed between the distributor plugbox on the fly jib and the distributor plugbox on the main boom. The weight of the hoist limit switch of the main boom must be removed and then mounted on the hoist limit switch of the boom extension or of the fly jib.



If the hoist limit switch weight is not repositioned, the hoist limit switch system cannot work properly. During work with the boom extension / fly jib, no weights should be mounted on the hoist limit switch of the main boom.

- **Cranes with main and auxiliary hoisting gear**

If the main boom extension or fly jib is not used, the override plug must be inserted into the distributor plugbox on the main boom and the hoist limit switch weight must be mounted on the main boom.

If the crane is working with a main boom extension or a fly jib, the connecting cable must be installed between the distributor plugbox on the boom extension or the fly jib and the distributor plugbox on the main boom. Moreover, weights must be mounted to the hoist limit switch of the main boom and the boom extension or the fly jib.

If the boom extension or the fly jib is in working position, and if the main boom is not equipped with a winch rope, then the weight of the hoist limit switch must be removed from the main boom in order to eliminate any risk to persons or damage to the equipment.

After the electrical cable connections have been checked for the rig arrangement in question, the following inspections must also be carried out:

1. Check all cable connections to the system components for damage.
2. Check the hoist limit switches and hoist limit switch weights for ease of movement.

Checks before start-up

3. Check the spring-loaded cable drum for ease of running, drum pre-tension and correct cable winding.
4. Check the mechanical and the electrical installation of the load cells on the fly jib (if fitted).

 **WARNING**

The checks described below must be carried out carefully in order to prevent damage to the crane and injury to persons. The correct function of the LMI system depends on successful completion of these checks before work is started. If the crane operator cannot see the hook block while approaching the pulley head, he must instruct an assistant (slinger) to help him. The crane operator must be ready to stop the crane immediately if the LMI system does not work correctly, that is, if the red warning lamps do not light up, the acoustic alarm does not sound and crane movements, such as hoisting, telescopic extension and lowering cannot be disabled.

Check the hoist *limit switch warning lamp* and the acoustic alarm as follows:

1. Manually lift the weight attached to the hoist limit switch. As soon as the weight is lifted, the acoustic alarm should sound and the *Hoist limit switch warning lamp* should light up.
2. Use the main hoisting gear to pull the hook block slowly against the hoist limit switch weight. As soon as the hook block starts lifting the weight, the acoustic alarm should be actuated, the *hoist limit switch warning lamp* should light up and the main hoisting gear should be switched off. Lower the hook block slightly in order to terminate this state.
3. Lower the main boom slowly using the boom elevation in order to bring about a possible hoist limit state. As soon as the hook block starts lifting the weight, the acoustic alarm should sound, the *hoist limit switch warning lamp* should light up and the boom elevation should be switched off. Lower the hook block slightly in order to terminate this state.
4. Slowly extend the telescopic boom in order to bring about a possible hoist limit state. As soon as the hook block starts lifting the weight, the acoustic alarm should sound, the *hoist limit switch warning lamp* should light up and the telescoping function should be switched off. Lower the hook block slightly in order to terminate this state.

 **WARNING**

If the warning lamp and the acoustic alarm do not function as described, and if the crane movements are not disabled, the system is not working properly. The fault must be eliminated before work is started.

5. If the crane is fitted with a main boom extension or a fly jib, the test must be repeated for the hoist limit switch of the boom extension / fly jib.

Checks before start-up

6. Check whether the displayed main boom length corresponds to the actual length.
7. Check whether the displayed angle of the main boom corresponds to the actual angle.
8. Check whether the displayed working radius of the crane corresponds to the actual working radius.
9. Check the load display by lifting a known weight. The accuracy of the load display must be within the given tolerance.

5.1 Operation

After being set correctly, the LMI is ready to operate. The crane operator must therefore be familiar with all the control elements of the LMI and enter the correct commands before the crane can start work. All settings must be tested by lifting a known weight and comparing this with the information displayed by the LMI.

The figures in the load chart contain the weight of the hook block, the load securing ropes and other load lifting devices. This combined weight must be deducted from the figures in the load chart in order to determine the net load to be lifted.



If any of the displays shows a discrepancy between the values displayed and the actual values, please contact your local PAT Service Centre for repair of your system or to have calibration of the LMI tested.

Contacts: www.hirschmann-ac.de



Any modification of the crane structure or changes to the crane require subsequent testing of the LMI's calibration.

6. SERVICE AND MAINTENANCE

Maintenance of the Automatic Safe Load Indicator (LMI) comprises the inspection of the following:

1. Wiring connecting the various parts of the system. If a cable is damaged, it must be replaced immediately.
2. The insulation of the length transmitter rope or the hoist limit switch cable and of the cable guides. If the insulation is worn, or the cables guides damaged, these parts should be replaced.
3. Inspection of the hoist limit switch for ease of movement.
4. Inspection of the cable drum for sufficient pre-tension.
5. Inspection of the pressure sensors on the boom elevation cylinders and connection hoses for oil leaks.



Staff who have not been specially trained may only eliminate the faults listed in the error table, but must not replace any defective mechanical parts or cables.

Service and maintenance

6.1 Info menu

The system comprises a menu structure which shows typical system information

Call up function::

By actuating key



Info

piston	21.8
rod	25.5
main boom angle	58.2
main boom length	51.8



return to normal display



Service and maintenance

6.2 Service menu

The system comprises a menu structure which shows information for service purpose

During the service function, the system interrupts crane movements temporarily. Moreover, the warning lamps (7) and (8) go on.

Call up function: By actuating key 
(normal menu / layer 3)

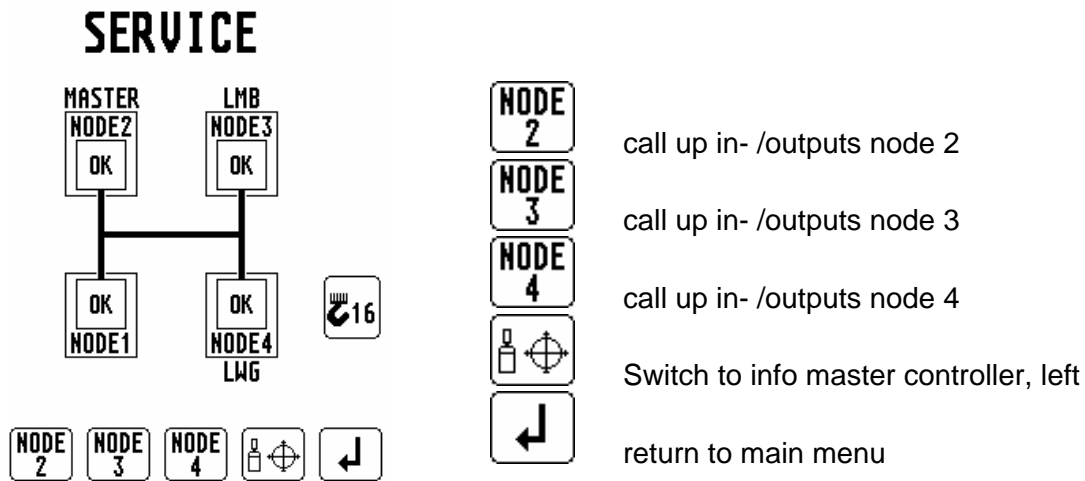

for further information to operate the service menus refer to appendix „description of menu structure“



Troubleshooting

7. TROUBLESHOOTING

7.1 General information

In the event of a malfunction or operator error detected by the system, a code "E xx" (LMI error) or "S xxxx" (control error) appears on the *data display* (1), thus specifying the reason for the malfunction.

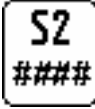
Error LMI system: 

Error control system:  or 

The error codes listed in the error table explain the various errors that can occur in the LMI system. Faults in the LMI system caused by exceeding the predefined ranges or through operator error caused by the crane operator can normally be remedied by the crane operator himself. Faults in the microprocessor system **may only** be remedied by factory-trained after-sales service staff. In this case, please contact the PAT after-sales service.

7.2 Error messages LMI system (E ##)

System programm: refer to page "revision history" in this manual

Error Code	Error	Cause	Elimination
E01	Fallen below radius range or angle range exceeded	<ul style="list-style-type: none"> Fallen below the minimum radius or gone past the maximum angle specified in the respective load chart due to luffing up the boom too far 	<ul style="list-style-type: none"> Luff down the boom to a radius or angle specified in the load chart.
E02	Radius range exceeded or fallen below angle range	<ul style="list-style-type: none"> Gone past the maximum radius or fallen below the minimum angle specified in the respective load chart due to luffing down the boom too far 	<ul style="list-style-type: none"> Luff up the boom to a radius or angle specified in the load chart.

Troubleshooting

Error Code	Error	Cause	Elimination
E04	Operating mode not acknowledged or not available	<ul style="list-style-type: none"> A non existing operating mode has been selected 	Set the correct operating mode for the operating state in question
E05	Prohibited length range	<ul style="list-style-type: none"> Boom has been extended either too far or not far enough, e.g. if it is prohibited to go beyond a certain maximum boom length or with load curves for jibs where the main boom has to be extended to a certain length Length sensor adjustment has changed, e.g. the cable slid off the length sensor reel. Clutch between length sensor pot and drive is defective 	<ul style="list-style-type: none"> Extend/retract boom to the correct length Retract boom. Check the prestress of the cable reel (cable must be taut). Open the length sensor and carefully turn the length sensor pot counterclockwise until the detent by means of a screw driver Replace the complete clutch including drive wheel and adjust length sensor pot as described above
E11	Fallen below lower limit value for measuring channel "length main boom"	<ul style="list-style-type: none"> Length potentiometer is defective Electronic component in the measuring channel is defective 	<ul style="list-style-type: none"> Replace length potentiometer Replace sensor unit
E12	Fallen below the lower limit value in the measuring channel "pressure piston side"	<ul style="list-style-type: none"> Pressure transducer is defective. Electronic component in the measuring channel is defective. 	<ul style="list-style-type: none"> Replace pressure transducer Replace sensor unit
E13	Fallen below lower limit value in the measuring channel "pressure rod side"	<ul style="list-style-type: none"> refer to E12 	<ul style="list-style-type: none"> refer to E12
E15	Fallen below lower limit value in measuring channel "angle main boom"	<ul style="list-style-type: none"> Angle potentiometer defective Electronic component in the measuring channel defective. 	<ul style="list-style-type: none"> Replace angle sensor Replace sensor unit

Troubleshooting

Error Code	Error	Cause	Elimination
E21	Upper limit value in measuring channel "main boom length" has been exceeded.	<ul style="list-style-type: none"> refer to E11 	<ul style="list-style-type: none"> refer to E11
E22	Upper limit value in measuring channel "pressure piston side" has been exceeded	<ul style="list-style-type: none"> refer to E12 	<ul style="list-style-type: none"> refer to E12
E23	Upper limit value in measuring channel "pressure rod side" has been exceeded.	<ul style="list-style-type: none"> refer to E12 	<ul style="list-style-type: none"> refer to E12
E25	Upper limit value in measuring channel "main boom angle" has been exceeded.	<ul style="list-style-type: none"> refer to E15 	<ul style="list-style-type: none"> refer to E15
E37	Error in the logical program flow	<ul style="list-style-type: none"> System program file is defective Flash-EPROM defective 	<ul style="list-style-type: none"> Upload valid system software Replace central unit
E38	System program and crane data file do not match.	<ul style="list-style-type: none"> The system program in the LMI does not match to the programming in the crane data file 	<ul style="list-style-type: none"> Upload valid system program file or the valid crane data file
E39	System program and load chart file do not match	<ul style="list-style-type: none"> The system program in the LMI and the programming in the load chart file do not match. 	<ul style="list-style-type: none"> Upload valid system program file or the valid load chart file
E3A	crane data file and load chart file do not match	<ul style="list-style-type: none"> The crane type in the crane data file and the programming in the load chart file do not match. 	<ul style="list-style-type: none"> Upload crane data programming with the same crane type in the crane data file and the load chart file
E43	Error in the write/read memory, (RAM)	<ul style="list-style-type: none"> Write/read memory (RAM) or central unit defective. 	<ul style="list-style-type: none"> Replace central unit
E47	Error in the monitored write/ read memory. The CRC verification of the monitored write/read memory provides an incoherent result	<ul style="list-style-type: none"> The CRC sign of the monitored write/read memory is wrong The buffer battery is discharged (< 2V at 1kOhm). Central unit defective. 	<ul style="list-style-type: none"> Restart the LMI Replace buffer battery on the central unit. Replace central unit
E51	Error in the crane data file	<ul style="list-style-type: none"> No valid data in the crane data file. Flash-EPROM defective 	<ul style="list-style-type: none"> Upload valid crane data file Replace central unit

Troubleshooting

Error Code	Error	Cause	Elimination
E52	Error in load chart file.	<ul style="list-style-type: none"> No valid data in the load chart file Flash-EPROM defective 	<ul style="list-style-type: none"> Upload valid load chart file Replace central unit
E56	Error in crane data file.	<ul style="list-style-type: none"> No valid data in the crane data file during calibration. Flash-EPROM defective 	<ul style="list-style-type: none"> Restore or upload valid crane data file Replace central unit
E57	Error in serial crane data file.	<ul style="list-style-type: none"> Calibration data file does not contain valid data. Flash-EPROM defective 	<ul style="list-style-type: none"> Upload calibration data file Replace central unit
E61	Error in the CAN bus data transfer for all CAN units	<ul style="list-style-type: none"> CAN Bus cable between the central unit and the sensor unit defective or not connected. Can bus port in the central unit defective Short circuit in a CAN Bus cable 	<ul style="list-style-type: none"> Check the connection between the central unit and the sensor units Replace the central unit Replace Can Bus cable
E64	Error in the can bus data transfer of the length/angle sensor unit	<ul style="list-style-type: none"> Cable between the central unit and the sensor unit defective. Can bus port in the central unit defective Can bus port in the sensor unit is defective Sensor unit is defective 	<ul style="list-style-type: none"> Check the cable to the sensor unit Replace the central unit Replace the sensor unit Replace the sensor unit
E65	Error in the can bus length/angle sensor unit	<ul style="list-style-type: none"> The analog values of the sensor unit are invalid 	<ul style="list-style-type: none"> Replace the sensor unit
E84	Wrong rigging condition.	<ul style="list-style-type: none"> The selected rigging condition is not contained in the crane data file. 	<ul style="list-style-type: none"> Select another rigging condition Check the programming in the crane data file.
E85	Error in the radius determination	<ul style="list-style-type: none"> The computed radius is too small (negative deflection) 	<ul style="list-style-type: none"> Check the programming in the crane data file.
E87	Error in length measurement. The telescope combination determined does not correspond to the length measurement.	<ul style="list-style-type: none"> Measurement total length defective Wrong telepercentage from telecontrol Tolerance in DGA 11.1.4 too close 	<ul style="list-style-type: none"> Check length measurement main boom length (refer to E21) Check length measurement tele cylinder (refer to E21) increase tolerance

Troubleshooting

Error Code	Error	Cause	Elimination
EAB	short-circuit in A2B switch	<ul style="list-style-type: none"> short-circuit in A2B switch module short-circuit in A2B cable 	<ul style="list-style-type: none"> replace A2B switch replace cable
EAC	Interruption in A2B switch	<ul style="list-style-type: none"> Interruption in A2B switch module Interruption in A2B cable 	<ul style="list-style-type: none"> replace A2B switch replace cable
EBO	Rope layer different between calculation and dig inputs	<ul style="list-style-type: none"> Rope length not calibrated Invalid digital inputs 	<ul style="list-style-type: none"> Carry out online function '5', Turn off layer check with digital inputs
EDB	Overload recorder – parameter failure	<ul style="list-style-type: none"> parameter programming deleted (serial EEPROM or battery buffered RAM) 	<ul style="list-style-type: none"> re-setup overload recorder if failure appears sporadically: press "Horn off" button
EDC	Overload recorder – watchdog triggered	<ul style="list-style-type: none"> operation time limit exceeded 	<ul style="list-style-type: none"> reset system connect terminal and read out messages
EDD	battery low voltage	<ul style="list-style-type: none"> battery test: low voltage 	<ul style="list-style-type: none"> exchange battery and set time again if failure appears sporadically: press "Horn off" button
EDE	Overload recorder – data record was not written	<ul style="list-style-type: none"> another task busy with writing data record 	Reset system to reset error indication
EDF	Overload recorder – flash block full	<ul style="list-style-type: none"> maximum storing capacity exceeded 	Reset system or LMI overload active / start with new flash block
EFD	Failure LMI watchdog time extension	<ul style="list-style-type: none"> function which needs more than 0.5 s is active i.e. write Flash PROM 	Message removes automatically after a few seconds

Note:

Should an error message be displayed which is not included in the above list, please contact your local PAT After-Sales Service.

Troubleshooting

7.3 Error Codes, Control (S2/S3)

Error code	Error	Elimination
S2/S3 01xx ↓	Master controller defective	<ul style="list-style-type: none"> • Check wiring if required repair or exchange ECU
1E	left y-direction	
1F	left y-direction, contacts hang	
20	left x-direction	
21	left x-direction, contacts hang	
22	right y-direction	
23	right y-direction, contacts hang	
24	right x-direction	
25	right x-direction, contacts hang	

Error code	Error	Elimination
S2/S3 02xx ↓	Error of Control Parameter Menu (CPM)	<ul style="list-style-type: none"> • Reprogramming of ECU • Exchange of ECU
xx	Number of CPM with error (hexadecimal). Default-value is active.	

Error code	Error	Elimination
S2/S3 08xx ↓	Error of analog input	<ul style="list-style-type: none"> • Check wiring • Check sensor • Exchange of ECU
10	System-pressure-sensor without function.	

Note:

Should an error message be displayed which is not included in the above list, please contact your local PAT After-Sales Service.

Troubleshooting

7.4 Error Codes, Control (S2)

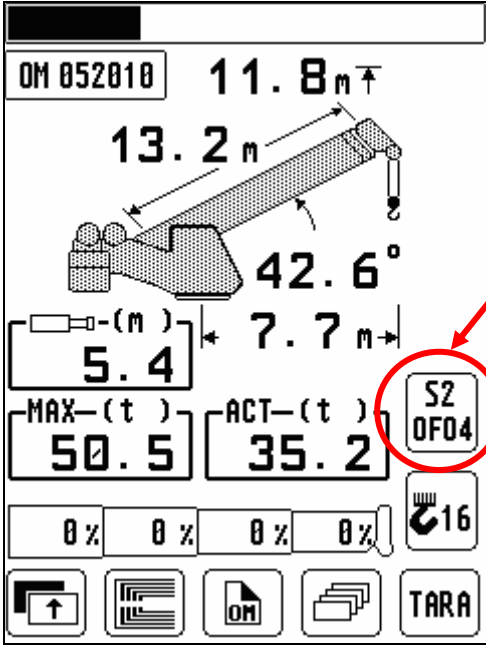
Error code	Error	Elimination
<p>S2 0Fxx</p> <p>↓</p>	<p>ECU defective</p>	
<p>03</p>	<p>LMB-ECU communicates not on the CAN</p>	<ul style="list-style-type: none"> • Check CAN-wires • Exchange LMB-ECU (node 3)
<p>04</p>	<p>PWM-controller of Master-ECU without function. Movements “swing left + right”, “winch up + down” and “elevating down” are stopped and only possible in manual mode (activation and use of manual mode see operation manual, chapter B2).</p>  <p>The screenshot shows a control panel with the following data: 'OM 052010', '11.8 m ↑', '13.2 m', '42.6 °', '5.4', '7.7 m', 'MAX-(t) 50.5', 'ACT-(t) 35.2', and a circled error code 'S2 0F04'. A red arrow points to the error code. At the bottom, there are four '0%' indicators, a '16' indicator, and buttons for '↑', 'OM', and 'TARA'.</p>	<ul style="list-style-type: none"> • Exchange Master-ECU (node 2)

Note:



Should an error message be displayed which is not included in the above list, please contact your local PAT After-Sales Service.

Appendix: Description of menu structure





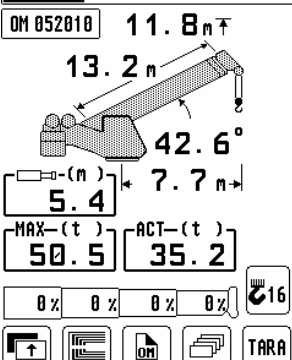
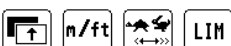

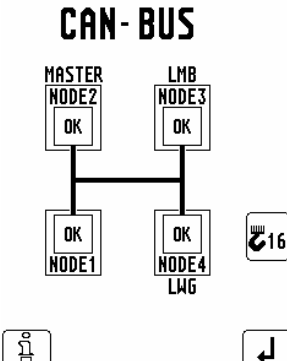





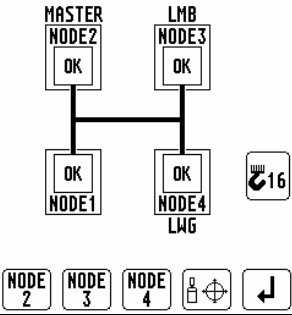













Description of menu structure

Display	Description of function keys
 Control & Service System	<p>no function key</p>
<p>Select language</p> <p> <input type="checkbox"/> 1 FÜR DEUTSCH <input type="checkbox"/> 2 FOR ENGLISH <input type="checkbox"/> 3 VOOR NEDERLANDS <input type="checkbox"/> 4 POUR FRANCAIS </p> <p> <input type="checkbox"/> 1 <input type="checkbox"/> 2 <input type="checkbox"/> 3 <input type="checkbox"/> 4 <input type="checkbox"/> 2 </p>	<p> 1: language selection: german 2: language selection: english 3: language selection: dutch 4: language selection: french 5: switch over to layer 2 for selection of other languages </p>
<p>Select language</p> <p> <input type="checkbox"/> 5 PARA ESPANOL <input type="checkbox"/> 6 PER ITALIANO <input type="checkbox"/> 7 FOR RUSSIAN </p> <p> <input type="checkbox"/> 5 <input type="checkbox"/> 6 <input type="checkbox"/> 7 <input type="checkbox"/> 1 </p>	<p> F1 (5): language selection: spanish F2 (6): language selection: italian F3 (7): language selection: russian F4: F5: back to layer 1 </p>

Appendix: Description of menu structure

Display	Description of function keys
	<ol style="list-style-type: none"> 1: switch to layer 2 2: switch to telescope menu 3: select operating mode / reeving 4: select content of multi symbol field 5: tare function
	<ol style="list-style-type: none"> 1: switch to layer 3 2: select unit meter / feet 3: call up master controller menu 4: select geometrical limitation 5:
	<ol style="list-style-type: none"> 1: switch to layer 1 2: call up language selection menu 3: call up telescope control menu 4: call up service menus 5: call up bus info menu
	<ol style="list-style-type: none"> 1: switch to info for bus symbols 2: 3: 4: 5: return to LMI screen

Appendix: Description of menu structure

Display	Description of function keys																																				
<p>INFO</p> <p> <input type="checkbox"/> OK operational <input checked="" type="checkbox"/> preoperational <input checked="" type="checkbox"/> lost <input checked="" type="checkbox"/> stopped  <input checked="" type="checkbox"/> hardware failure </p> <p></p>	<p>1: 2: 3: 4: 5: return to bus menu</p>																																				
<p>SERVICE</p> <p>  </p> <p> <input type="checkbox"/> NODE 2 <input type="checkbox"/> NODE 3 <input type="checkbox"/> NODE 4  </p>	<p>1: digital inputs Node2 Basis 2: digital inputs Node3 Basis 3: analog inputs Node 4 4: switch to master controller left 5: return to LMI screen</p>																																				
<p>NODE2</p> <table border="1"> <thead> <tr> <th>BASIC</th> <th>BASIC</th> <th>BASIC</th> <th>BUS</th> </tr> </thead> <tbody> <tr> <td>DI 049</td> <td>DI 857</td> <td>DI 1665</td> <td></td> </tr> <tr> <td>150</td> <td>958</td> <td>1766</td> <td></td> </tr> <tr> <td>251</td> <td>1059</td> <td>1867</td> <td></td> </tr> <tr> <td>352</td> <td>1160</td> <td>1968</td> <td></td> </tr> <tr> <td>453</td> <td>1261</td> <td>2333</td> <td></td> </tr> <tr> <td>554</td> <td>1362</td> <td></td> <td></td> </tr> <tr> <td>655</td> <td>1463</td> <td></td> <td></td> </tr> <tr> <td>756</td> <td>1564</td> <td></td> <td></td> </tr> </tbody> </table> <p>  DIG OUT ANA IN ANA OUT  </p>	BASIC	BASIC	BASIC	BUS	DI 049	DI 857	DI 1665		150	958	1766		251	1059	1867		352	1160	1968		453	1261	2333		554	1362			655	1463			756	1564			<p>1: digital inputs Node2 extension 2: digital outputs Node2 Basic 3: analog inputs Node2 Basic / extension 4: analog outputs Node2 Basic / extension 5: return to service menu</p>
BASIC	BASIC	BASIC	BUS																																		
DI 049	DI 857	DI 1665																																			
150	958	1766																																			
251	1059	1867																																			
352	1160	1968																																			
453	1261	2333																																			
554	1362																																				
655	1463																																				
756	1564																																				
<p>NODE2</p> <table border="1"> <thead> <tr> <th>BASIC</th> <th>BASIC</th> <th>BUS</th> </tr> </thead> <tbody> <tr> <td>DO 002</td> <td>DO 814</td> <td></td> </tr> <tr> <td>103</td> <td>915</td> <td></td> </tr> <tr> <td>204</td> <td>1016</td> <td></td> </tr> <tr> <td>305</td> <td>1117</td> <td></td> </tr> <tr> <td>406</td> <td>1218</td> <td></td> </tr> <tr> <td>507</td> <td>1319</td> <td></td> </tr> <tr> <td>608</td> <td>1420</td> <td></td> </tr> <tr> <td>709</td> <td>1521</td> <td></td> </tr> </tbody> </table> <p> <input type="checkbox"/> DIG IN  ANA IN ANA OUT  </p>	BASIC	BASIC	BUS	DO 002	DO 814		103	915		204	1016		305	1117		406	1218		507	1319		608	1420		709	1521		<p>1: digital inputs Node2 Basic 2: digital outputs Node2 extension 3: analog inputs Node2 Basic / extension 4: analog outputs Node2 Basic / extension 5: return to service menu</p>									
BASIC	BASIC	BUS																																			
DO 002	DO 814																																				
103	915																																				
204	1016																																				
305	1117																																				
406	1218																																				
507	1319																																				
608	1420																																				
709	1521																																				

Appendix: Description of menu structure

Display	Description of function keys																																																						
<p>NODE2</p> <table border="1"> <thead> <tr> <th colspan="2">BASIC</th> <th colspan="2">EXTENTION</th> </tr> </thead> <tbody> <tr> <td>AI</td><td></td> <td>AI</td><td></td> </tr> <tr> <td>0</td><td>34</td> <td>0</td><td>34</td> </tr> <tr> <td>1</td><td>35</td> <td>1</td><td>35</td> </tr> <tr> <td>2</td><td>36</td> <td>2</td><td>36</td> </tr> <tr> <td>3</td><td>37</td> <td>3</td><td>37</td> </tr> <tr> <td>4</td><td>38</td> <td>4</td><td>38</td> </tr> <tr> <td>5</td><td>39</td> <td>5</td><td>39</td> </tr> <tr> <td>6</td><td>40</td> <td>6</td><td>40</td> </tr> <tr> <td>7</td><td>41</td> <td>7</td><td>41</td> </tr> </tbody> </table> <p>DIG IN DIG OUT ANA OUT</p>	BASIC		EXTENTION		AI		AI		0	34	0	34	1	35	1	35	2	36	2	36	3	37	3	37	4	38	4	38	5	39	5	39	6	40	6	40	7	41	7	41	<p>1: digital inputs Node2 Basic 2: digital outputs Node2 Basic 3: 4: analog outputs Node2 Basic / extension 5: return to service menu</p>														
BASIC		EXTENTION																																																					
AI		AI																																																					
0	34	0	34																																																				
1	35	1	35																																																				
2	36	2	36																																																				
3	37	3	37																																																				
4	38	4	38																																																				
5	39	5	39																																																				
6	40	6	40																																																				
7	41	7	41																																																				
<p>NODE2</p> <table border="1"> <thead> <tr> <th colspan="2">BASIC</th> <th colspan="2">EXTENTION</th> </tr> </thead> <tbody> <tr> <td>AD</td><td>F</td> <td>AD</td><td>F</td> </tr> <tr> <td>0</td><td>02</td> <td>0</td><td>02</td> </tr> <tr> <td>1</td><td>04</td> <td>1</td><td>04</td> </tr> <tr> <td>2</td><td>06</td> <td>2</td><td>06</td> </tr> <tr> <td>3</td><td>08</td> <td>3</td><td>08</td> </tr> <tr> <td></td><td></td> <td>4</td><td>14</td> </tr> <tr> <td></td><td></td> <td>5</td><td>16</td> </tr> <tr> <td></td><td></td> <td>6</td><td>18</td> </tr> <tr> <td></td><td></td> <td>7</td><td>20</td> </tr> </tbody> </table> <p>DIG IN DIG OUT ANA IN</p>	BASIC		EXTENTION		AD	F	AD	F	0	02	0	02	1	04	1	04	2	06	2	06	3	08	3	08			4	14			5	16			6	18			7	20	<p>1: digital inputs Node2 Basic 2: digital outputs Node2 extension 3: analog inputs Node2 Basic / extension 4: 5: return to service menu</p>														
BASIC		EXTENTION																																																					
AD	F	AD	F																																																				
0	02	0	02																																																				
1	04	1	04																																																				
2	06	2	06																																																				
3	08	3	08																																																				
		4	14																																																				
		5	16																																																				
		6	18																																																				
		7	20																																																				
<p>NODE3</p> <table border="1"> <thead> <tr> <th colspan="2">BASIC</th> </tr> </thead> <tbody> <tr> <td>AI</td><td></td> </tr> <tr> <td>0</td><td>34</td> </tr> <tr> <td>1</td><td>35</td> </tr> <tr> <td>2</td><td>36</td> </tr> <tr> <td>3</td><td>37</td> </tr> <tr> <td>4</td><td>38</td> </tr> <tr> <td>5</td><td>39</td> </tr> <tr> <td>6</td><td>40</td> </tr> <tr> <td>7</td><td>41</td> </tr> </tbody> </table> <p>DIG IN DIG OUT ANA OUT</p>	BASIC		AI		0	34	1	35	2	36	3	37	4	38	5	39	6	40	7	41	<p>1: digital inputs Node3 Basic 2: digital outputs Node3 Basic 3: frei 4: alalog outputs Node3 Basic 5: return to service menu</p>																																		
BASIC																																																							
AI																																																							
0	34																																																						
1	35																																																						
2	36																																																						
3	37																																																						
4	38																																																						
5	39																																																						
6	40																																																						
7	41																																																						
<p>NODE3</p> <table border="1"> <thead> <tr> <th>BASIC</th> <th>BASIC</th> <th>BASIC</th> </tr> </thead> <tbody> <tr> <td>DI</td><td></td><td>DI</td> </tr> <tr> <td>0</td><td>49</td> <td>8</td><td>57</td> <td>16</td><td>65</td> </tr> <tr> <td>1</td><td>50</td> <td>9</td><td>58</td> <td>17</td><td>66</td> </tr> <tr> <td>2</td><td>51</td> <td>10</td><td>59</td> <td>18</td><td>67</td> </tr> <tr> <td>3</td><td>52</td> <td>11</td><td>60</td> <td>19</td><td>68</td> </tr> <tr> <td>4</td><td>53</td> <td>12</td><td>61</td> <td>23</td><td>33</td> </tr> <tr> <td>5</td><td>54</td> <td>13</td><td>62</td> <td></td><td></td> </tr> <tr> <td>6</td><td>55</td> <td>14</td><td>63</td> <td></td><td></td> </tr> <tr> <td>7</td><td>56</td> <td>15</td><td>64</td> <td></td><td></td> </tr> </tbody> </table> <p>DIG OUT ANA IN ANA OUT</p>	BASIC	BASIC	BASIC	DI		DI	0	49	8	57	16	65	1	50	9	58	17	66	2	51	10	59	18	67	3	52	11	60	19	68	4	53	12	61	23	33	5	54	13	62			6	55	14	63			7	56	15	64			<p>1: 2: digital outputs Node3 Basic 3: analog inputs Node3 Basic 4: analog outputs Node3 Basic 5: return to service menu</p>
BASIC	BASIC	BASIC																																																					
DI		DI																																																					
0	49	8	57	16	65																																																		
1	50	9	58	17	66																																																		
2	51	10	59	18	67																																																		
3	52	11	60	19	68																																																		
4	53	12	61	23	33																																																		
5	54	13	62																																																				
6	55	14	63																																																				
7	56	15	64																																																				

Appendix: Description of menu structure

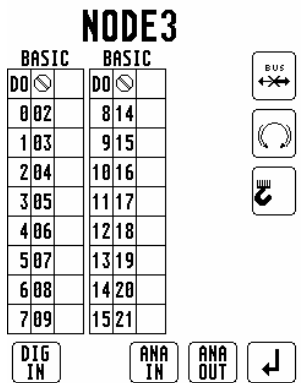
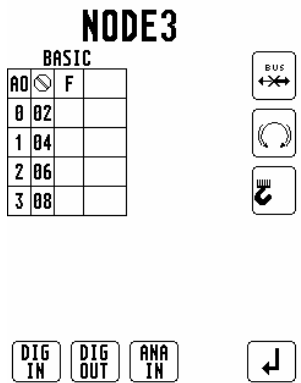
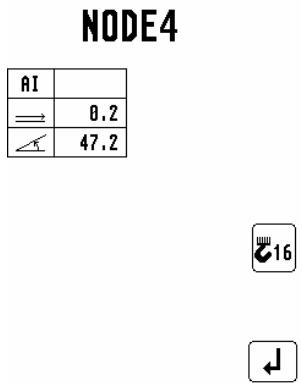
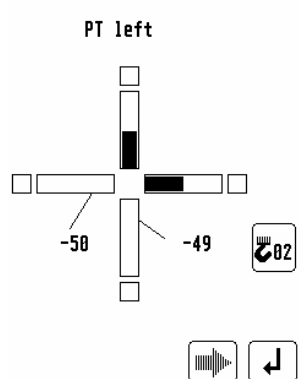
Display	Description of function keys
	<p>1: digital inputs Node3 Basic</p> <p>2:</p> <p>3: analog inputs Node3 Basic</p> <p>4: analog outputs Node3 Basic</p> <p>5: return to service menu</p>
	<p>1: digital inputs Node3 Basic</p> <p>2: digital outputs Node3 Basic</p> <p>3: analog inputs Node3 Basic</p> <p>4:</p> <p>5: return to service menu</p>
	<p>1:</p> <p>2:</p> <p>3:</p> <p>4:</p> <p>5: return to service menu</p>
	<p>1:</p> <p>2:</p> <p>3:</p> <p>4: switch to master controller, right</p> <p>5: return to service menu</p>

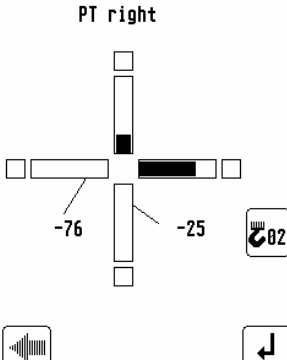
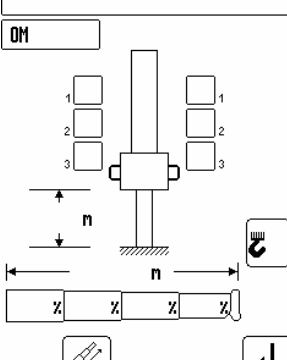
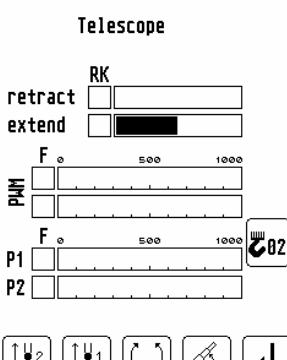
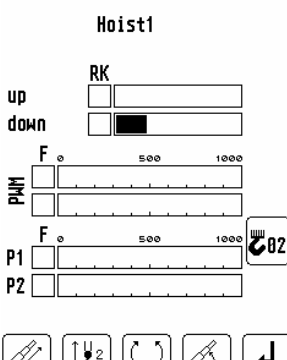

Appendix: Description of menu structure

Display	Description of function keys
<p style="text-align: center;">PT right</p> 	<p>1: switch to master controller, right</p> <p>2:</p> <p>3:</p> <p>4:</p> <p>5: return to service menu</p>
<p style="text-align: center;">OM</p> 	<p>1:</p> <p>2: switch to control telescope</p> <p>3:</p> <p>4:</p> <p>5: return to LMI menu</p>
<p style="text-align: center;">Telescope</p> <p style="text-align: center;">RK</p> <p>retract <input type="checkbox"/></p> <p>extend <input checked="" type="checkbox"/></p> <p>F 0 500 1000</p> <p>PM1 <input type="checkbox"/></p> <p>F 0 500 1000</p> <p>P1 <input type="checkbox"/></p> <p>P2 <input type="checkbox"/></p> 	<p>1: switch to control hoist 2</p> <p>2: switch to control hoist 1</p> <p>3: switch to control slewing gear</p> <p>4: switch to control luffing gear</p> <p>5: return to LMI screen</p>
<p style="text-align: center;">Hoist1</p> <p style="text-align: center;">RK</p> <p>up <input type="checkbox"/></p> <p>down <input checked="" type="checkbox"/></p> <p>F 0 500 1000</p> <p>PM1 <input type="checkbox"/></p> <p>F 0 500 1000</p> <p>P1 <input type="checkbox"/></p> <p>P2 <input type="checkbox"/></p> 	<p>1: switch to control telescope</p> <p>2: switch to control hoist 2</p> <p>3: switch to control slewing gear</p> <p>4: switch to control luffing gear</p> <p>5: return to LMI screen</p>

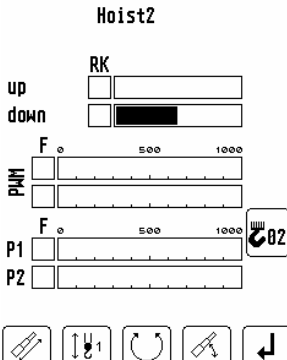
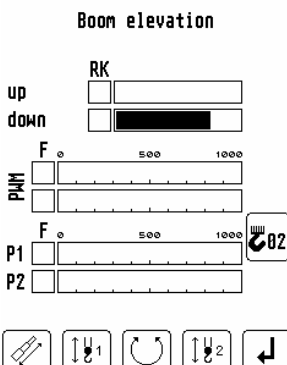
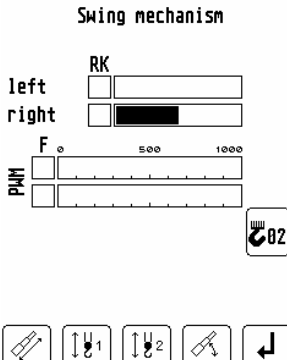
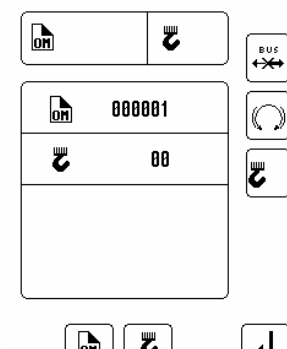
Appendix: Description of menu structure

Display	Description of function keys
 <p>The 'Hoist2' screen displays a control interface for the hoist. It includes a 'RK' (Remote Key) section with 'up' and 'down' buttons. Below this are two 'F' (Falls) indicators with scales from 0 to 1000. There are also 'PM1' and 'P2' indicators. At the bottom, there are five function keys: a pencil icon, a vertical arrow with '1', a circular arrow, a diagonal arrow with '2', and a return key.</p>	<ol style="list-style-type: none"> 1: switch to control telescope 2: switch to control hoist 1 3: switch to control slewing gear 4: switch to control luffing gear 5: return to LMI screen
 <p>The 'Boom elevation' screen displays a control interface for boom elevation. It includes a 'RK' section with 'up' and 'down' buttons. Below this are two 'F' indicators with scales from 0 to 1000. There are also 'PM1' and 'P2' indicators. At the bottom, there are five function keys: a pencil icon, a vertical arrow with '1', a circular arrow, a vertical arrow with '2', and a return key.</p>	<ol style="list-style-type: none"> 1: switch to control telescope 2: switch to control hoist 1 3: switch to control slewing gear 4: switch to control luffing gear 2 5: return to LMI screen
 <p>The 'Swing mechanism' screen displays a control interface for the swing mechanism. It includes a 'RK' section with 'left' and 'right' buttons. Below this are two 'F' indicators with scales from 0 to 1000. There are also 'PM1' and 'P2' indicators. At the bottom, there are five function keys: a pencil icon, a vertical arrow with '1', a vertical arrow with '2', a diagonal arrow with '2', and a return key.</p>	<ol style="list-style-type: none"> 1: switch to control telescope 2: switch to control hoist 1 3: switch to control hoist 2 4: switch to control luffing gear 5: return to LMI screen
 <p>The menu screen displays a control interface for system settings. It includes a 'BUS' section with a double-headed arrow icon. Below this are three input fields: the first contains '000001', the second contains '00', and the third is empty. At the bottom, there are three function keys: a pencil icon, a circular arrow, and a return key.</p>	<ol style="list-style-type: none"> 1: 2: input operating code 3: input number of falls (reeving) 4: 5: return to LMI screen

Appendix: Description of menu structure

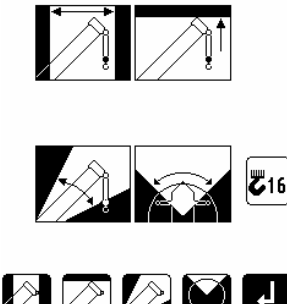
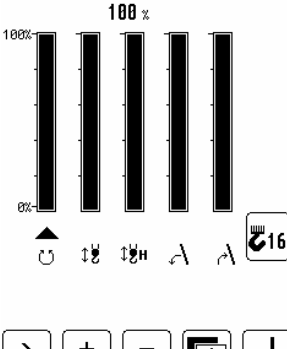
Display	Description of function keys
	<ol style="list-style-type: none"> 1: Set cursor to the left by one digit 2: Set cursor to the right by one digit 3: decrease marked value 4: increase marked value 5: Finish input / return to last menu
	<ol style="list-style-type: none"> 1: confirm input 2: frei 3: frei 4: frei 5: discard inputs
	<ol style="list-style-type: none"> 1: select radius limitation menu 2: select height limitation menu 3: select boom angle limitation menu 4: select slewing angle limitation menu 5: return to LMI screen
	<ol style="list-style-type: none"> 1: Activate bar to the right of the one being edited 2: Increase marked value by 1 %. 3: Decrease marked value by 1 %. 4: Switch over to quick setting option (next layer) 5: return to LMI screen

Appendix: Description of menu structure

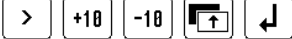
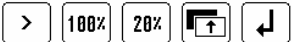
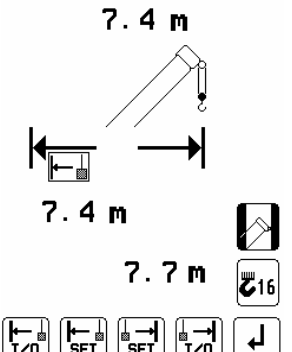
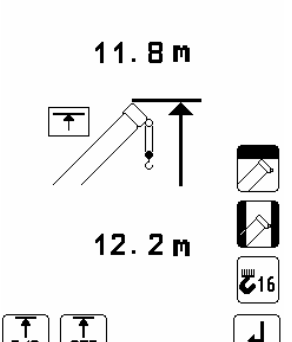
Display	Description of function keys
	<ol style="list-style-type: none"> 1: Activate bar to the right of the one being edited 2: Increase marked value by 10 %. 3: Decrease marked value by 10 %. 4: switch to next layer 5: return to LMI screen
	<ol style="list-style-type: none"> 1: Activate bar to the right of the one being edited 2: set marked value to 100% 3: set marked value to 20% 4: switch to next layer 5: return to LMI screen
	<ol style="list-style-type: none"> 1: switch on/off left radius limit 2: set left radius as left limit 3: set right radius as right limit 4: switch on/off right radius limit 5: return to limit selection menu
	<ol style="list-style-type: none"> 1: switch on/off hight limit 2: set actual hight as hight limit point 3: 4: 5: return to limit selection menu

Appendix: Description of menu structure

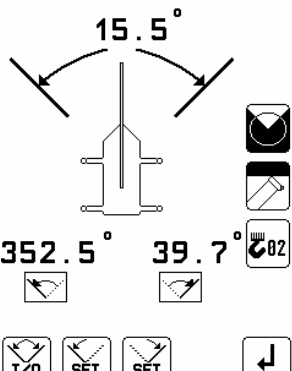
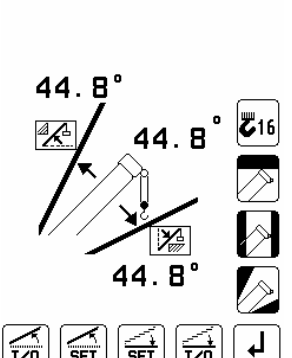
Display	Description of function keys
	<ol style="list-style-type: none"> 1: switch on/off left slewing angle limits 2: set left slewing angle as left limit 3: set right slewing angle as right limit 4: 5: return to limit selection menu
	<ol style="list-style-type: none"> 1: switch on/off left boom angle limit 2: set left boom angle as left limit 3: set right boom angle as right limit 4: switch on/off right boom angle limit 5: return to limit selection menu

Annex: Important notes for crane operators and crane operating companies

INSTRUCTIONS 1 Shut-off values for boom cranes with variable load ratings depending on variable working radius

The crane shut-off values are determined by us based on the load charts and design drawings specified by the crane manufacturer.

These theoretical shut-off values must be checked by means of tests on the crane with weighed test loads for all modes and at least with the following rig arrangements, depending on the crane design.

- **Cranes with fixed boom length in operation:**
Smallest, medium and largest radius for shortest, medium and longest boom length, as well as shortest, medium and longest fly jibs for these boom lengths.
- **Cranes with boom length variable in operation:**
Smallest, medium and largest radius for each length increment as well as for all fly jibs.

INSTRUCTIONS 2 Important notes for the crane operator

The LMI is an operating aid to warn the crane operator of an imminent overload or of the hook block approaching the boom head, in order to avoid possible damage to property or personal injury.

This system cannot be, and is not intended to be, a substitute for good judgement or experience on the part of the crane operator, or for the application of recognised, safe working methods when using cranes. The crane operator is not released from his obligation to operate the crane safely. He must ensure that he fully understands and follows the notes and instructions displayed. Before beginning work with the crane, the crane operator must carefully read and understand the entire Manual to ensure that he is aware of the operation of the LMI and the crane. Proper functioning depends on due daily inspection of the system and compliance with the operating instructions listed in this Manual.

The system can only offer the crane operator help if the LMI is correctly adjusted, and the correct load chart and the correct operating code have been entered for the particular rig arrangement. To avoid damage to property and serious or even fatal injuries to persons, it is essential to ensure that the LMI is correctly adjusted before beginning crane work.



This system could be equipped with a key-operated switch which is located in the microprocessor central unit. This key-operated switch overrides the LMI's shut-off feature. The switch may only be actuated in emergencies by authorized personnel. Non-compliance with these instructions may lead to damage to property and serious or even fatal injuries to persons.

Annex: Important notes for crane operators and crane operating companies

INSTRUCTIONS 3 Important notes for the crane operating company

In the Federal Republic of Germany, the design of overload safety devices for cranes is subject to the directives of VDI standard 3570 (VDI = Verein Deutscher Ingenieure - Association of German Engineers). The significance and the limitations of overload safety devices are also pointed out in this directive.

"In the operation of cranes, overload safety devices are intended to prevent accidents and risks to persons, property, the load and the crane as far as possible as a result of overloading. The crane operating company and the crane operator must remember that an overload safety device cannot detect all hazards in good time, and that a malfunction is possible through influences that are not apparent. For this reason, you cannot be released from your obligation to exercise due care and from your responsibility for complying with the operating regulations and the load limits of the crane. Overload safety devices must not be used for standard operation. They should only react in emergencies. The load rating of the hoisting equipment must not be reduced by an overload safety device."

VDMA Instruction Sheet for Overload Safety Devices (Automatic Safe Load Indicators) for Boom Cranes

According to § 24 of the UVV (provisions for the prevention of accidents) "Boom cranes", the boom crane delivered to you is equipped with an overload safety device (automatic safe load indicator) which switches off the crane's hoisting gear and the boom retracting mechanism when the admissible load moment is exceeded. In order to enable discharging after the overload safety device has reacted, it must still be possible to perform a contrary movement. This means, for example, that it must still be possible to lower the load after the hoisting gear has been switched OFF.

An overload safety device (automatic safe load indicator) is installed to prevent crane use for lifting of loads which endanger its stability. Thus, the overload safety device (automatic safe load indicator) is an emergency switch which, in case of crane overloads, shuts off all movements which might increase the load moment, and thus prevents possible damage or accidents. In order to enable the overload safety device to fulfil its functions as a safety unit, please pay attention to the following instructions:

1. Overload safety devices (automatic safe load indicators) must not be used for switching off the hoisting gear or the boom retracting mechanism during normal operation. The crane operator has to make sure in all cases before such work that the lifting capacity is not exceeded by the load to be lifted. Loads which exceed the lifting capacity of the crane must not be lifted in spite of the fact that the overload safety device is installed. This device must not be used for weighing purposes, and the crane must not be charged with loads exceeding the individually highest admissible load.
2. Tearing off fixed loads is only admissible if the crane manufacturer has agreed to it, and only with cranes which are specially equipped for this purpose. During such operations, the overload safety device (automatic safe load indicator) must not be used as load measuring equipment for normal operation.
3. The overload safety device installed in the crane must be serviced at regular intervals and checked for safe operation before crane work. According to § 35 of the UVV (Provisions for the Prevention of Accidents) "Boom cranes", crane maintenance work also comprises regular inspections of the overload safety device.
4. In general, the overload safety device is not automatically adjusted to the different modes of operation of the crane. Therefore the crane operator is obliged to adjust the overload safety device to a different range of lifting capacities or load moments, when the mode of operation of the crane is altered. To this effect, the operating instructions of the manufacturer of the installed overload safety device must be complied with. Safe operation of the machine and crane work free of accidents depend to a large extent on careful compliance with these instructions. An incorrectly set overload safety device, e.g. a device which is set to a high load moment while the outriggers are retracted, is considerably more dangerous than a crane without an overload safety device, as it conveys a feeling of safety to the driver, which is in fact not justified, and which may cause serious accidents.

Annex: Important notes for crane operators and crane operating companies

5. The overload safety device (automatic safe load indicator) installed must be adjusted by the crane driver to the different ranges of lifting capacities or load moments, when the crane is adjusted to different modes of operation, such as:
 - a) when the outriggers are extended or retracted (switching over to the high or low load moment)
 - b) when the boom length is changed by:
 - manual extending and retracting (telescoping)
 - mounting or dismounting intermediate elements;
 - c) when the crane is swung or slewed into the range of the higher or lower stability moment (switching over to the high or low load moment)
 - d) when changing over to a different lifting capacity range by fitting multiple rope falls to the hoisting gear or the boom retracting mechanism.

6. Please note positively that the overload safety device cannot become effective, i.e. the drive assembly cannot be switched off quickly enough when the crane is operated incorrectly. In this case, accidents cannot be precluded completely in spite of the overload safety device being installed. This applies particularly to the following cases:
 - the hook or the load lifting equipment is fixed underneath the load;
 - excessive time-lag forces are effective;
 - loads are dropped into the rope;
 - the load is pulled diagonally;
 - moving the crane in an area with significant ground slope;
 - subsiding subsoil;
 - wind load.

7. If an equipment for switching off or overriding the overload safety device (automatic safe load indicator) is installed, it may only be used if particular precautions have been taken, and in the presence of the crane supervisors, e.g. during crane inspections and during the operations intended by the crane manufacturer.

Careful compliance with the provisions comprised in this instruction sheet and in the operating manual of the crane manufacturer is a prerequisite to safe operation of the overload safety device (overload disconnect unit).

Should you have any doubts, please consult the manufacturer's Operating Manual. If it does not provide sufficient information, it will be necessary to contact the company in question.

Unauthorized tampering with the overload safety device's mechanical components will rule out all warranty claims.

Issued by: VDMA Fachgemeinschaft für Hebezeuge und Fördermittel
im Verein Deutscher Maschinenbau-Anstalten e.V.
Düsseldorf-Oberkassel

Annex: Important notes for crane operators and crane operating companies

INSTRUCTIONS 4 Notes on Electromagnetic Compatibility (EMC) in electronic systems taking account of the effect of electromagnetic fields

Electromagnetic fields are having an increasing effect on electronic systems and may lead to malfunctions; to avoid these, we have listed preventive measures in the following, according to the latest state of technology:

1. The preventive measures proceed primarily from the basic idea that the electronic circuits should be shielded from irradiated high frequencies by a closed, low-resistance protective skin against high-frequency interference.
 - All components are equipped with metallic outer housings with earthing option;
 - only cables with a braided screen are used. The screen must generously cover all connectors and must be of high conductivity;
 - coupling of the crane earth and the electronics earth in one single point of the system only.
2. The general precautions listed under Section 1 cannot assure complete protection against electromagnetic fields in all cases, however, since the size and type of effect depend on local conditions.

Examples of such influencing factors are:

- particularly unfavourable arrangement of the aerials in relation to the system,
- very high transmission power,
- consistent compliance with measures of Section 1 not possible due to local conditions,
- long cables,
- coupling of interference into the supply leads.

In unfavourable conditions, one has no choice but to take experimental measures on site, in addition to the preventive measures, while taking account of the principles mentioned in Section 1, for example:

- fitting filters or short-circuiting the interference frequencies using capacitors;
- establishing or separating earth connections;
- using a guarded shield system.

Annex: Important notes for crane operators and crane operating companies

INSTRUCTIONS 5 Notes on industrial safety when repairing display and control consoles

Caution: Liquid crystal displays contain liquid chemical substances in the display. Particular caution and care are therefore necessary:

- when operating equipment containing liquid crystal displays
- during storage and transport (risk of breakage !)
- when disposing of unusable or excess liquid crystal displays



Broken Displays !

Possible sources of danger are chemical effects in the event of skin contact with broken liquid crystal displays. In the event of contact, wash the affected skin areas thoroughly with soap. Be particularly careful with open wounds !

INSTRUCTIONS 6 Installation instructions for display and control consoles without closed metallic housing

To avoid radio interference, high-frequency devices and equipment coming under general approval requirements published by the Federal Minister for Post and Telecommunications in his Official Gazette No. 163/1984 as Decree No. 1045/1984 and No. 1046/1984 must comply with the limit values and conditions laid down there.

For display and control consoles without closed metallic housing (dashboard installation version), the conductor screen must therefore be mounted on the dashboard directly in front of the console by means of a bare cable clip.

Revision History

Revision History

Version	Date	Modifications	Name
Rev. A	2004-11-11	Issue according to german manual Rev. A (2004-09-15) for FAUN FA-035 / ATF 110 Console software: KFIT V 1.0 (6.09.2004)	Konopka
Rev. B	2005-10-07	addendum error code table E87 to EAC, EDB to EFD System programm: LFIT V 1.0 (17.01.2005)	Konopka
Rev. C	2006-04-24	Corrections / additions Console software: V 2.12 (13.01.2006) Id-No. 32 24 02 12 - 020	Konopka
Rev. D	2007-10-15	Corrections / additions	Konopka