

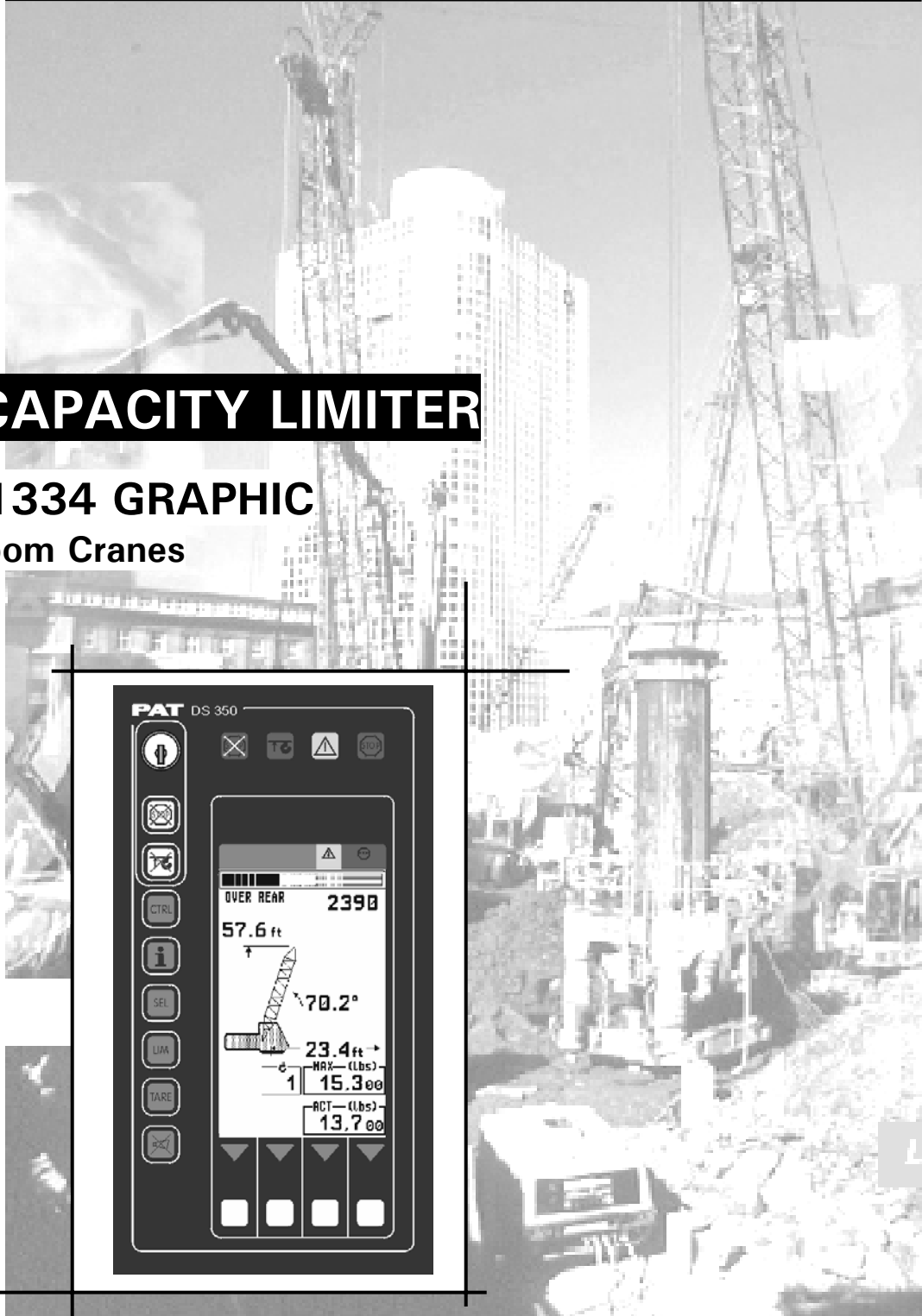

PAT



PAT

RATED CAPACITY LIMITER

DS 350 / 1334 GRAPHIC
for Lattice Boom Cranes

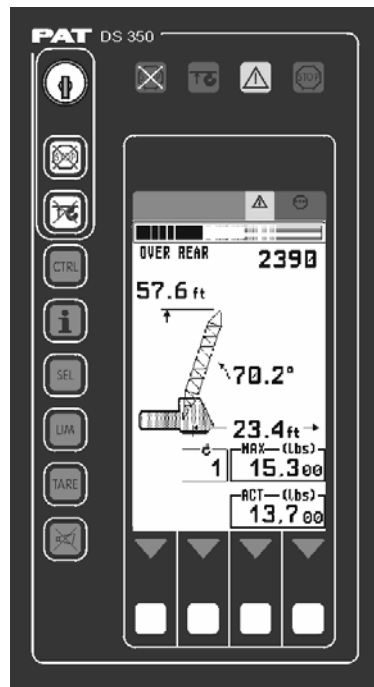

OPERATOR'S MANUAL

NOTICE

The information in this document is subject to change without notice.

PAT makes no warranty of any kind with regard to this material, including, but not limited to the implied warranties of merchantability and fitness for a particular purpose.

PAT shall not be liable for errors contained in this manual or for incidental or consequential damages in connection with the furnishing, performance, or use of this manual. This document contains proprietary information, which is protected by copyright. All rights are reserved.

No part of this document may be photocopied, reproduced, or translated to another language without the prior written consent of PAT.

MANUAL REVISIONS

REV	DATE	NAME	DESCRIPTION
C	06/29/01	CSH	ECN 01-155
D	04/12/02	CSH	ECN 02-133

TABLE OF CONTENTS

1	GENERAL INFORMATION	1
2	WARNINGS	1
3	SYSTEM DESCRIPTION	2
	3.1 SYSTEM FUNCTION	3
	3.2 OPERATING CONSOLE	3
	3.3 CONTROL IDENTIFICATION	4
4	CONFIGURATION SETUP.....	10
	4.1 RCL SETUP PROCEDURE.....	10
	4.2 HOIST-IN-USE QUICK SELECTION	16
	4.3 CRAWLER POSITION QUICK SELECTION	17
5	OPERATION.....	18
	5.1 LIMIT SETTING.....	21
	5.1.1 Radius Limitation	22
	5.1.2 Tip Height Limitation	24
	5.1.3 Boom Angle Limitation.....	26
	5.1.4 Slewing Angle Limitation / Virtual Wall Definition	28
	5.2 INFO CRANE CONFIGURATION	38
	5.3 DISPLAY CONTRAST CONTROL	39
6	PRE-OPERATION INSPECTION AND CALIBRATION VERIFICATION	40
7	SERVICE AND MAINTENANCE.....	44
8	TROUBLESHOOTING.....	45
	APPENDIX A: DETAILED SYMBOL EXPLANATION OF BOOM EXTENSIONS	47
	APPENDIX B: DETAILED SYMBOL EXPLANATION OF COUNTER WEIGHT OPTIONS.....	48

1 GENERAL INFORMATION

The PAT Rated Capacity Limiter (RCL) DS 350 has been designed to provide the crane operator with the essential information required to operate the machine within its design parameters.

Using different sensing devices, the Rated Capacity Limiter monitors various crane functions and provides the operator with a continuous reading of the crane's capacity. The readings continuously change as the crane moves through the motions needed to make the lift.

The RCL provides the operator with information regarding the angle of the boom, working radius, rated load and the total calculated weight being lifted by the crane.

If non permitted conditions are approached, the DS 350 Rated Capacity Limiter will warn the operator by sounding an audible alarm, lighting a warning light and locking out those functions that may aggravate the crane's condition.

2 WARNINGS

The RCL is an operational aid that warns a crane operator of approaching overload conditions and of over hoist conditions that could cause damage to equipment and personnel.

The device is not, and shall not, be a substitute for good operator judgment, experience and use of accepted safe crane operating procedures.

The responsibility for the safe crane operation shall remain with the crane operator who shall ensure that all warnings and instructions supplied are fully understood and observed.

Prior to operating the crane, the operator must carefully and thoroughly read and understand the information in this manual to ensure that he knows the operation and limitations of indicator and crane.

Proper functioning depends upon proper daily inspection and observance of the operating instructions set forth in this manual. Refer to Section 6. *Pre-Operation Inspection and Calibration Verification* of this handbook.



The RCL can only work correctly, if all adjustments have been properly set. For correct adjustment, the operator has to answer thoroughly and correctly all questions asked during the setup procedure in accordance with the real rigging state of the crane. To prevent material damage and serious or even fatal accidents, the correct adjustment of the RCL has to be ensured before starting the crane operation.

3 SYSTEM DESCRIPTION

The PAT Rated Capacity Limiter DS 350 consists of a central microprocessor unit, operating console, angle sensor, line riders, and anti-two block switches.

The system operates on the principle of reference/real comparison. The real value, resulting from the load measurement is compared with the reference data, stored in the central processor memory and evaluated in the microprocessor. When limits are reached, an overload warning signal is generated at the operator's console. At the same time, the aggravating crane movements, such as hoist up and boom down, will be stopped.

The fixed data regarding the crane, such as capacity charts, boom weights, centers of gravity and dimensions are stored in memory chips in the central processor unit. This data is the reference information used to calculate the operating conditions.

The boom angle is measured by the angle sensor, mounted in the boom base. The cable reel cable serves as an electrical conductor for the anti two-block switches and line rider signals.

The hoist load is measured by line riders mounted on top of the boom, close to the tip.

The interactive user guidance considerably simplifies the input of operating modes as well as the setting of geometry limit values.

Fig. 1: Components of the RCL system PAT DS 350

1. Operator's Console
2. Central Unit
3. Cable Reel
4. Boom Angle Sensor
5. Junction Box
6. Line rider (Tensiometer)
7. A2B Switch

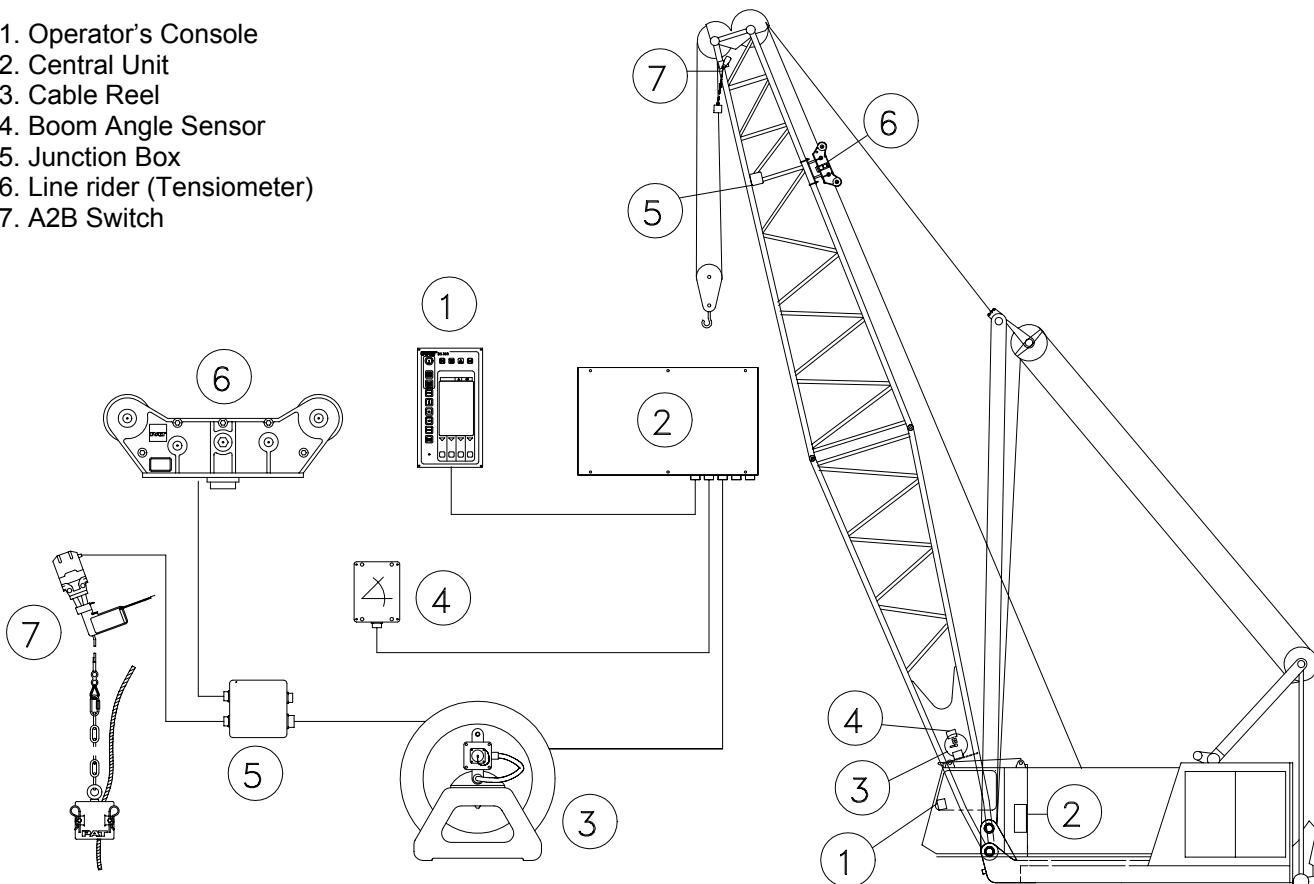

3.1 System Function

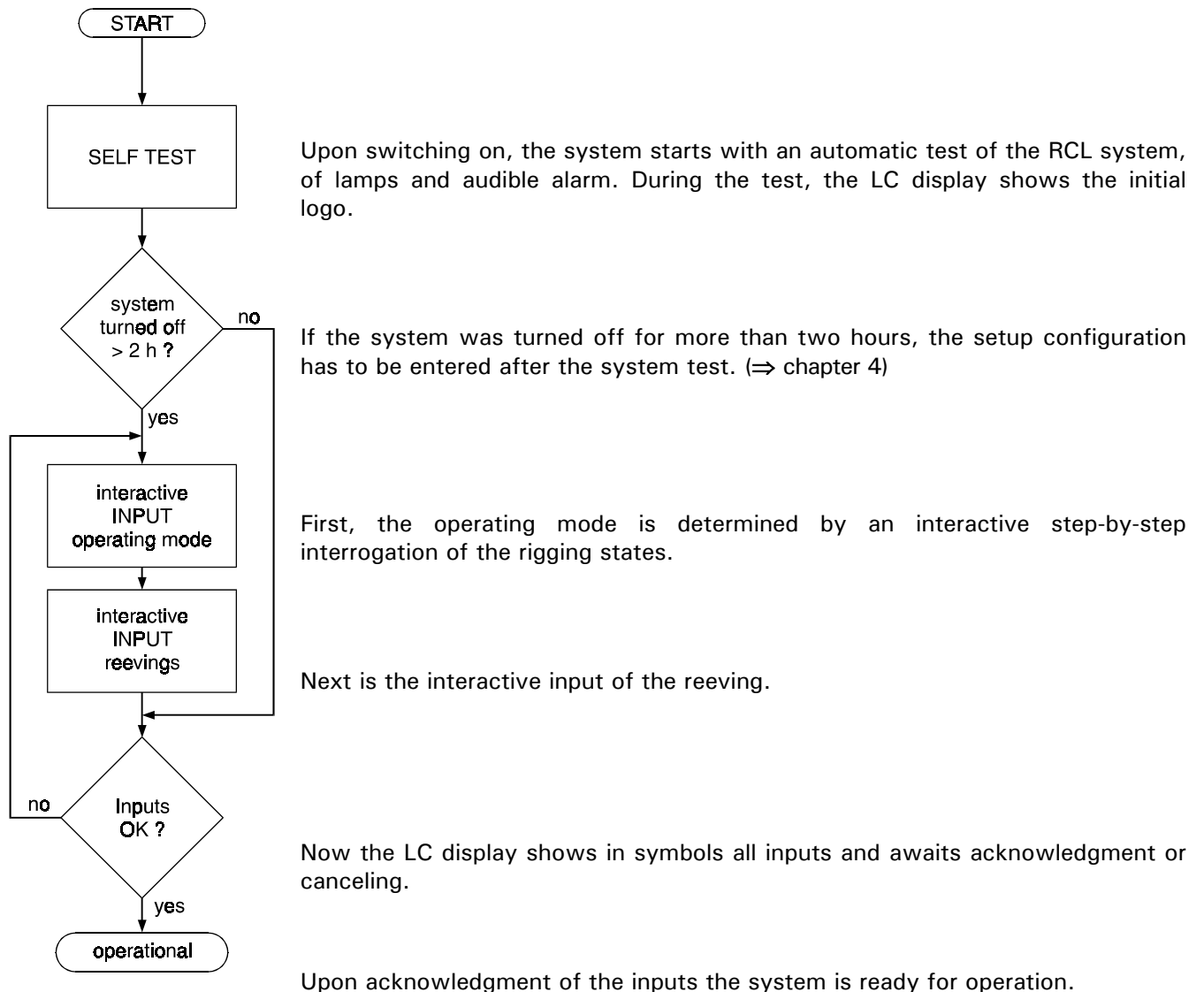

3.2 Operating Console

The console has 3 functions:

- inputs by the crane operator (operating mode, reeving)
- input of geometry limit values and signalization of exceeded limit values
- display of important data and information

The operator's console is mounted in the crane's cab in the operator's field of vision. For a better identification of displays and operating elements, they are continuously backlit during operation.

3.3 Control Identification

This unit contains a display and different controls which are described as follows:

Fig 2: *Operator's Console*

1. LC Display Area
2. Load Moment Limit Light
3. Load Moment Prewarning Light
4. Alarm Light "Anti-Two-Block"
5. By-Pass Warning Light
6. Button "Alarm Stop"
7. Button and Control Light "TARE"
8. Button and Control Light "LIMITS"
9. Button and Control Light "SELECT OPERATION MODE"
10. Button and Control Light "INFO"
11. Button and Control Light "CONTROL"
12. Audible Alarm
13. By-Pass Key Switch
14. Button and Control Light "By-Pass Anti-Two-Block"
15. Button and Control Light "By-Pass LMI Kick-out function"
- F1. Button "Function 1"
- F2. Button "Function 2"
- F3. Button "Function 3"
- F4. Button "Function 4"

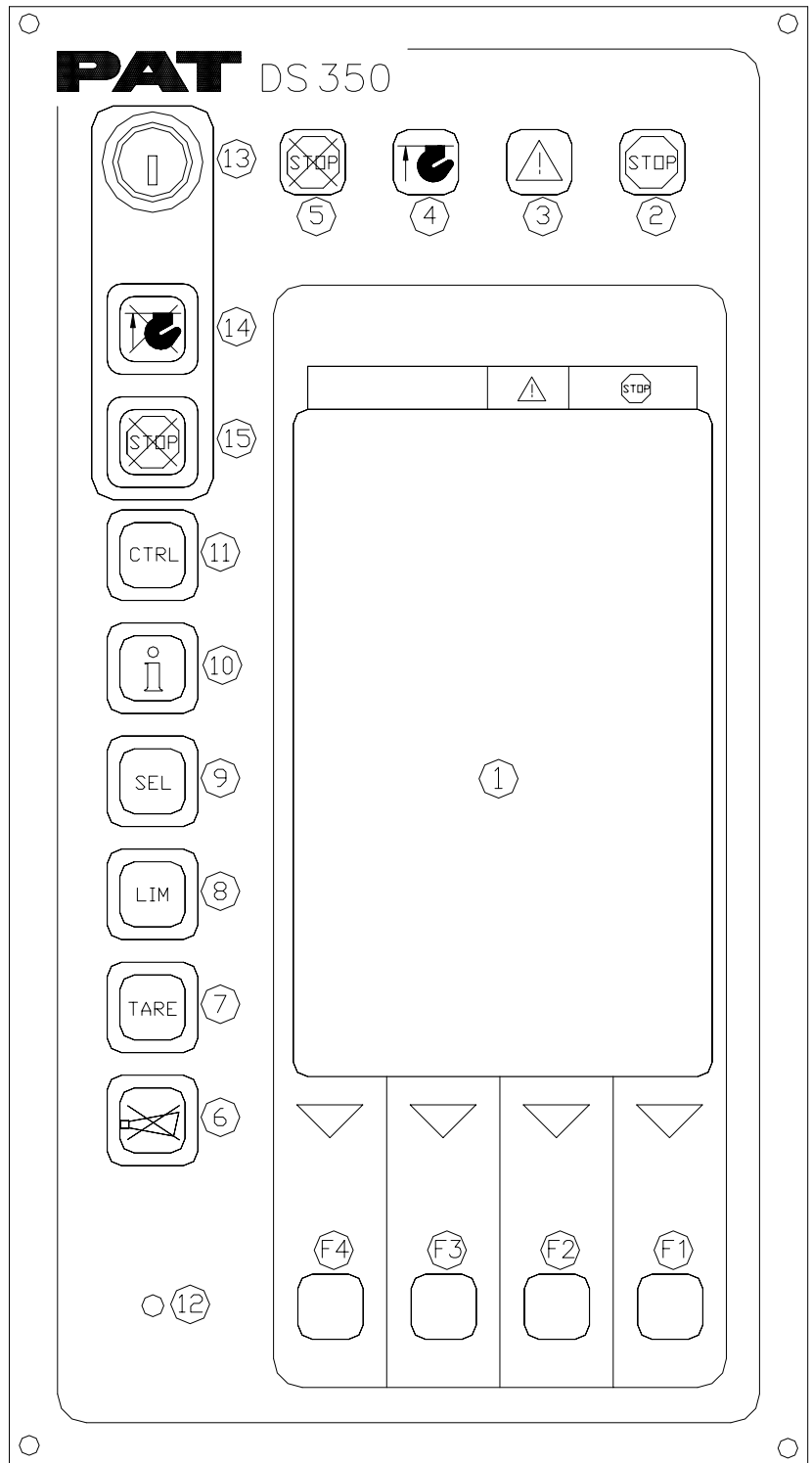

1 LC-Display

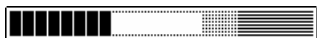

The LC display visualizes graphical symbols, texts and numerical values. Depending on the selected operating mode (setup, limit mode or RCL representation), the corresponding information is indicated on the display. Please refer to the description of the different operating modes for the

signification of the individual elements.

↔ 50.8 ft ↔

2 Rated Capacity Limit Light



The red RATED CAPACITY LIMIT LIGHT (2) warns the operator that a rated load condition has been reached. It lights up when the load on the crane reaches the crane load capacity. The audible alarm also sounds when this condition has been reached.

The following crane movements will be stopped concurrently:

- hoist up
- telescope out
- boom down

3 Rated Capacity Prewarning Light



The yellow RATED CAPACITY PRE-WARNING LIGHT (3) will light up when the load on the crane reaches the defined prewarning area, thus indicating that an overload condition is approaching.

This means for the operator to continue his crane operation with extreme caution.

4 Alarm Light "Anti-2-Block"



The red "Anti Two-Block Alarm Light" (4) lights up when the anti-two-block limit switch contacts open, indicating that a two-blocking condition is approaching. At the same time the audible alarm will sound.

The following crane movements will be stopped subsequently: hoist up and boom down (depending on your machine).

5 By-Pass Key Warning Light



The red BY-PASS WARNING LIGHT (5) flashes to indicate that the kick-out function of the A2B / RCL system is deactivated.

6 Button and Control Light "Alarm Stop"



This ALARM STOP BUTTON (6) allows the audible alarm to be silenced for approximately 15 seconds by pressing this button. Reference ⇒ "Audible Alarm" (12).

7 Button and Control Light "Tare"



The button "TARE" (7) is used to indicate the "Net load" on the LC Display (1). Net load is the present load, less lifting tackle and hook block. The Tare Button (7) has to be activated *before* lifting.

After pushing the "Tare Button" (7) the load display is set to zero (taring) and the control light lights up. After lifting a load the display shows the *net load* (pay load).

□The *net load* display will change to the actual load display when the boom radius is changed (either by angle or length).

8 Button "LIMITS"



Button to start the function "program limit values".
For the proceeding please refer to ⇒ chapter 5.1.

9 Button "SELECT"



Button to start the function "set operating mode".
For the proceeding please refer to ⇒ chapter 4.1.



The correct setting is of utmost importance for the proper function of the system and the crane. Therefore only operators who are thoroughly familiar with use and operation of the system shall set this button.

10 Button "INFO"



Button to start the function "information crane configuration"
Please refer to ⇒ chapter 5.2.

11 Button "CONTROL"



Button to start additional functions.
Please refer to ⇒ chapter 5.3.

12 Audible Alarm

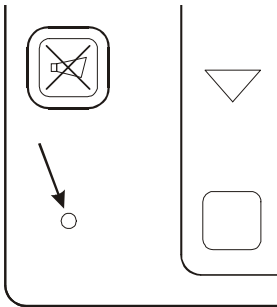

The AUDIBLE ALARM (12), sounds during the following conditions:

- overload condition
- approaching two-block condition
- preset limits reached
- malfunction of the RCL system
- operating error

□The alarm can be temporarily silenced by pushing the button "Alarm Stop" (6).

13 Key Switch

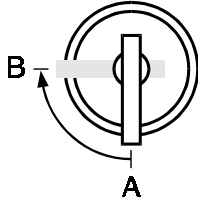

- The **anti-two-block** switch kick-out function is deactivated when the KEY SWITCH (13) is turned to position "B" **and** the "By-pass A2B" button (14) is pushed.

or

- The **RCL** kick-out function is deactivated when the KEY SWITCH (13) is turned to position "B" **and** the "By-pass RCL" button (15) is pushed.

KEY SWITCH (13) can be operated only by using the matching key.

WARNING

Since button (14) and (15) deactivate the kick-out function of the RCL system / the anti two-block system, the following instructions must be obeyed:

- The by-pass function shall be used with discretion, as unwarranted use of it to override the control lever lockout system can result in harm to the crane and danger to property and persons.
- Never use the by-pass function to either overload or operate the crane in a non-permissible range.

14 Button "By-pass A2B"

This button can be operated only if key switch (13) is turned to position B. While pushing this button, the kick-out function of the anti-two-block switch is deactivated. The By-Pass Warning Light (5) flashes to indicate that the kick-out function is deactivated.

15 Button "By-pass RCL"

This button can be operated only if key switch (13) is turned to position B. While pushing this button, the control lever lockout function of the RCL is deactivated. The By-Pass Warning Light (5) flashes to indicate that the kick-out function is deactivated.

4 CONFIGURATION SETUP

The RCL setup procedure allows the operator to input the crane configuration using interactive displays. The operator must complete the setup procedure for the Rated Capacity Limiter system if the system has been turned off for more than two hours or the crane operation configuration has been changed.

4.1 RCL Setup Procedure

- ...starts:**
 - *manually* at each modification of the crane configuration by pressing key (9) "SEL"
- ...is operated:**
 - by answering the different questions using functional keys F1...F4 in accordance with the actual configuration of the crane.
- ...is cancelled:**
 - any time by pressing again key (9) "SEL". The system, however, is only ready for operation, if the procedure has been completed and the selections have been confirmed.

If the system is turned off, all adjustments remain stored. When turning on again the system these adjustments can be acknowledged by merely pressing one key (provided that the crane configuration has not been modified!).

During the programming procedure the Rated Capacity Prewarning Light (3) and the Rated Capacity Limit Light (2) will light up and the aggravating crane movements will be interrupted.

Note:

If a configuration is selected which is not available, the display will indicate error code E04. In this case, the procedure has to be repeated with valid values!



The correct setting is of utmost importance for the proper functioning of the system and the crane. Therefore, only operators who are thoroughly familiar with the crane and the operation of the system should execute the setting of the system according to the operating configuration of the crane.

The RCL programming procedure consists of the following steps:

- setting the boom type configuration
- setting the counterweight configuration
- specify boom / setting the hoist configuration and reevings
- selecting the pick point
- confirmation of the programming procedure

For easy operation, the computer guides the operator through the procedure step by step. (interactive operation)

Definition of the Displayed Symbols:

The following illustrations define the symbols appearing on the display during the setup procedure. Not all symbols will be shown, depending on the crane type and the answers to the questions.

• **Setting the boom type configuration**

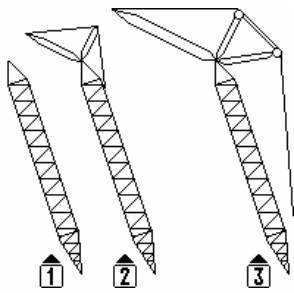

- 1** main boom / nose operation
- 2** fixed jib operation
- 3** luffing jib operation

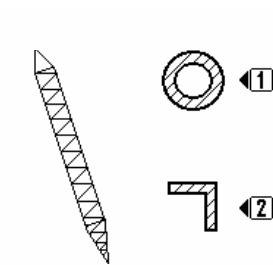

*if main boom/nose operation or jib operation selected:**

- 1** tube boom type
- 2** angular boom type

** this selection screen only appears, if both boom types are available on this crane*

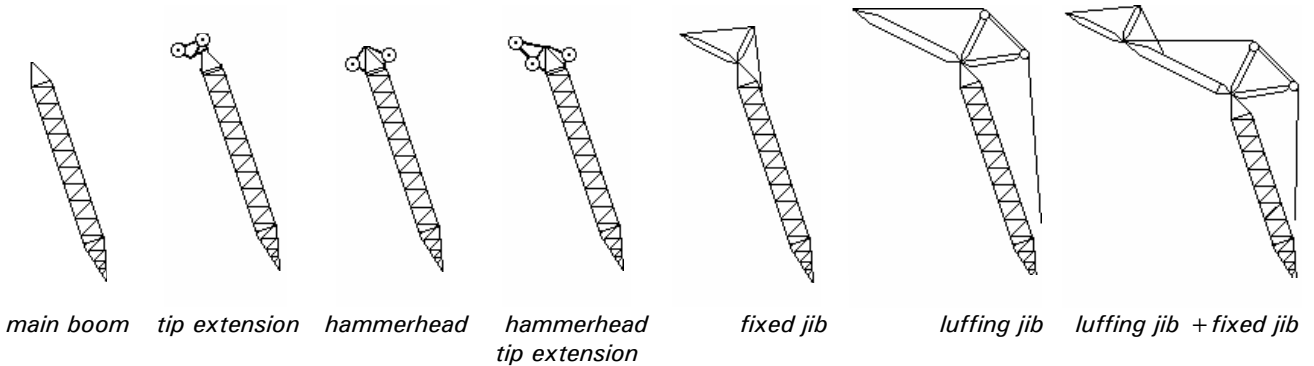

For detailed symbol explanation of extensions, please refer to Appendix A in this manual.

• **Setting the crawler / counterweight configuration**

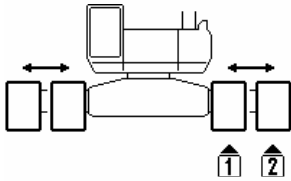

- 1** Retracted crawlers
- 2** Extended crawlers

• **Setting the counterweight configuration**

Depending on the model of your crane and counterweight options, please refer to Appendix B in this manual for detailed symbol explanation of counterweight.



- decrease counterweight
- +** increase counterweight
- OK** confirm counterweight

OR

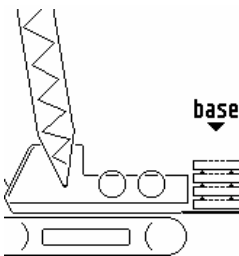

- +** increase counterweight
- OK** confirm counterweight

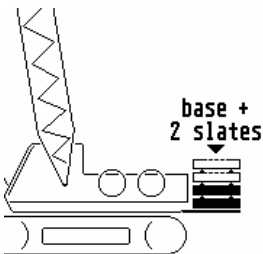

- decrease counterweight
- +** increase counterweight
- OK** confirm counterweight

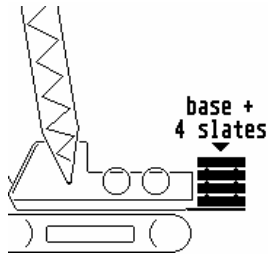

- decrease counterweight
- +** increase counterweight
- OK** confirm counterweight

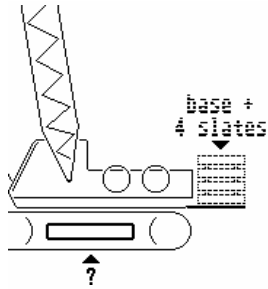

- Y** with additional lower counterweight
- N** without additional lower counterweight

• Specify boom / jib lengths (example luffing jib):

Select luffing jib length:

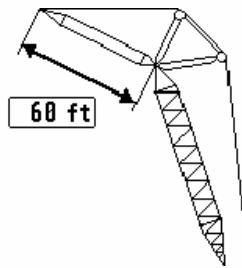

- decrease luffing jib length
- +** increase luffing jib length
- OK** confirm luffing jib length selection

Select main boom length:

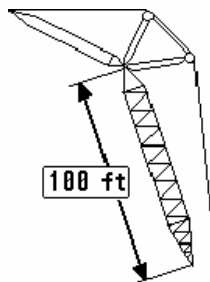

- +** increase main boom length
- decrease main boom length
- OK** confirm main boom length selection

• **Setting the hoist configuration and reeving (example luffing jib)**

The hoist selection can be made from 3 hoists, but only 2 hoists drum can be selected for one configuration.

Set front hoist drum pick point:

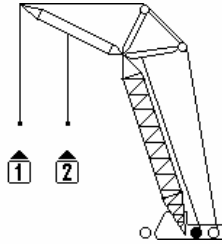

- 1** select pick point 1
- 2** select pick point 2
- N** no use of front hoist drum

Select front hoist reeving:

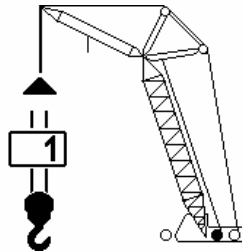

- decrease reeving
- +** increase reeving
- OK** confirm reeving

Set 3rd hoist drum pick point:

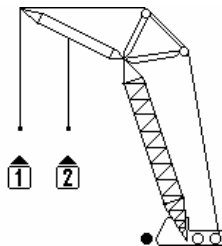

- 1** select pick point 1
- 2** select pick point 2
- N** no use of 3rd hoist drum

Select 3rd hoist reeving:

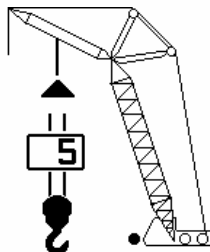

- decrease reeving
- +** increase reeving
- OK** confirm reeving

Once you have set the pick-points, you can switch between them by selecting which hoist drum is in use:

• **Select hoist-in-use (example luffing jib)**

Hoist-in-use selection:

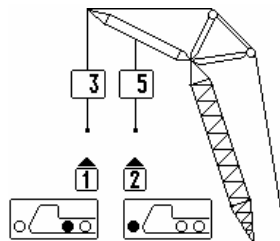

- 1** use pick point 1 as defined above
- 2** use pick point 2 as defined above

Under each pick point that you had set, you will find a symbol of the crane with the corresponding hoist drum filled in black.

- Confirmation of the programming procedure

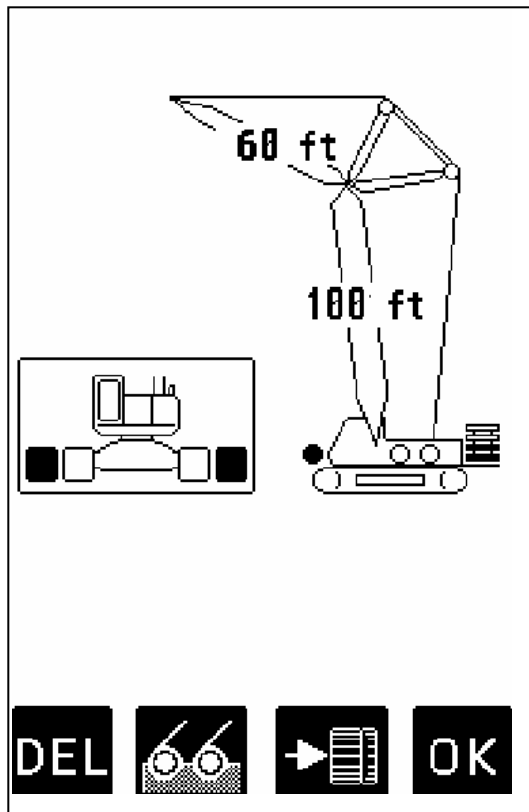

At the end of the procedure all selections are represented once again in symbolic forms. If selections have been made, the corresponding symbols are filled black (i.e. hoist drums).



Hoist-in-use quick selection
(⇒ chapter 4.2)



cancel procedure



crawler position quick selection
(⇒ chapter 4.3)



confirm inputs

4.2 Hoist-in-use quick selection

If, during the crane operation, the crane is switched over from using one hoist drum to the other, i.e. from front to rear hoist drum, the RCL system has to be adjusted to this modification. This modification can be entered without having to go through the whole RCL setup procedure again:



Call RCL setup procedure.

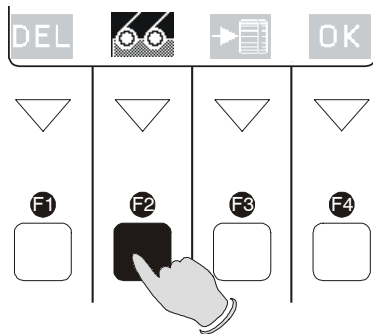

Directly call function "Hoist-in-use quick selection".

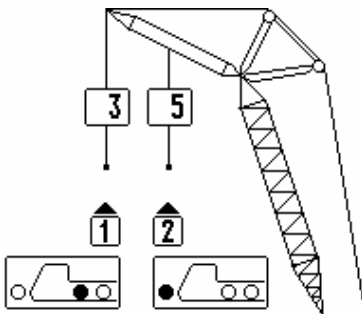

Select hoist in use (example):



1 use pick point 1 as defined

2 use pick point 2 as defined

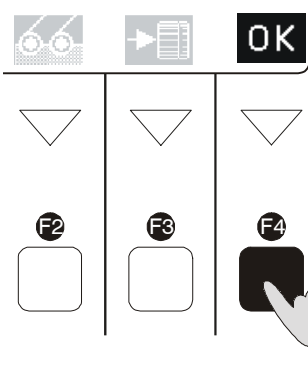

Confirm modification.

(call up the function again if you have selected the wrong hoist drum by mistake)

Note:

If a configuration is selected which is not available on the crane, the system will not accept the selection and the display will indicate the error code E04.

4.3 Crawler Position Quick Selection

If, during the crane operation, the position of the crawler tracks is changed, the RCL system has to be adjusted to this modification. The input of the crawler tracks position can be carried out directly without having to go through the whole RCL programming procedure again:



Call RCL Programming Procedure.

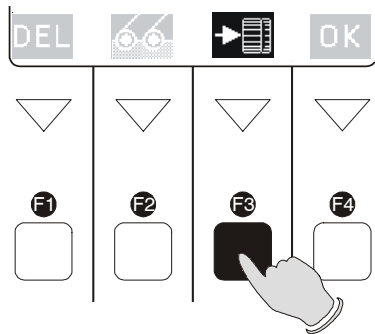

Directly call function " Crawler Position Quick Selection".

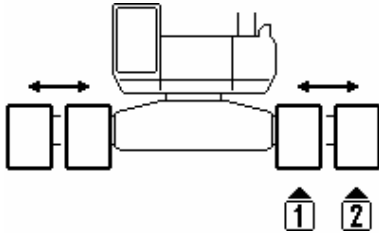

input of crawler position:

- 1** retracted crawlers
- 2** extended crawlers

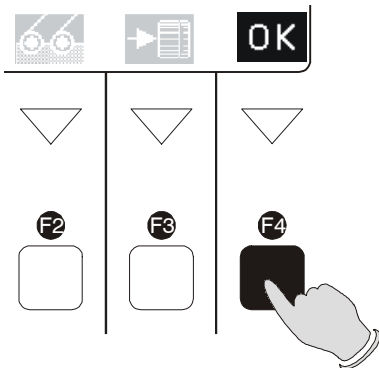

Confirm modification.

(select again the function if you made a wrong selection)

Note:

If a configuration is selected which is not available on the present crane, the system will not accept the selection and the display will indicate the error code E04.

5 OPERATION

After having set the RCL to the actual crane configuration, the system is ready for operation. The display shows the RCL screen (example for value representation). This example shows a typical operating screen for a crane with a "main boom" or "main boom with fixed jib" configuration:

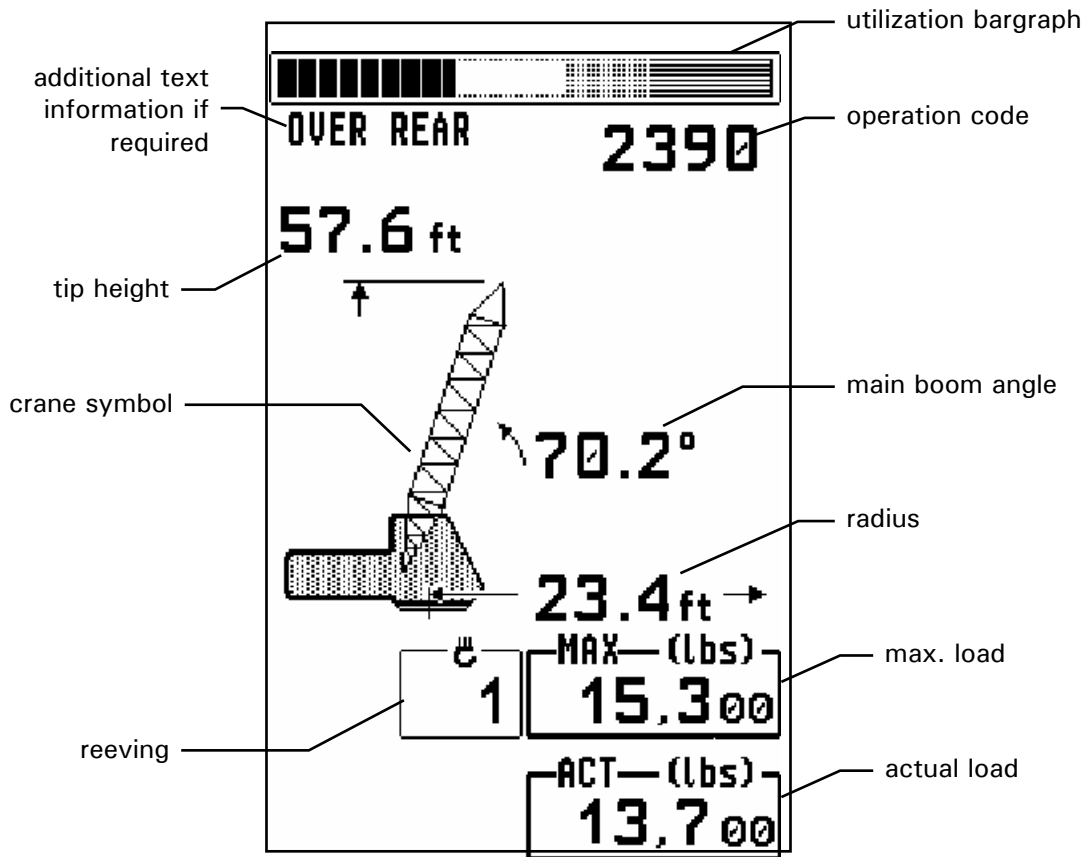





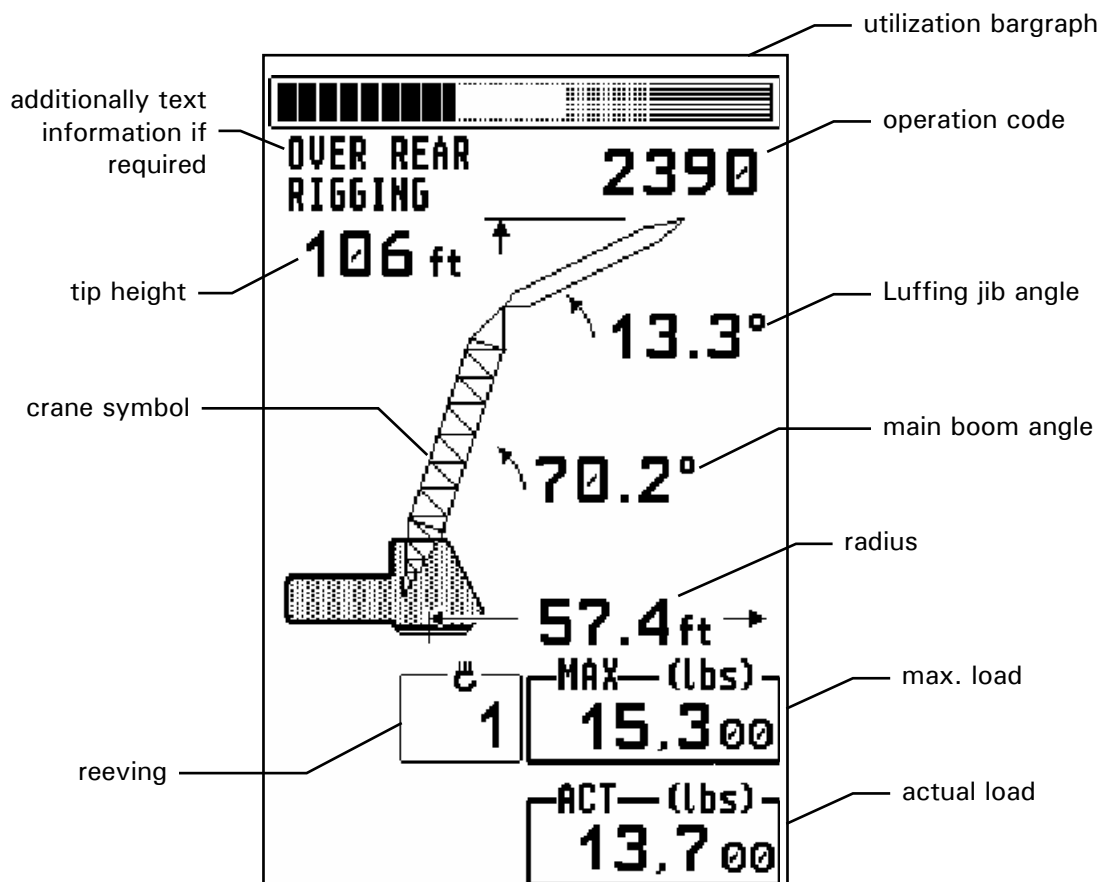

Please note that the crane symbol does not reflect the crane configuration that has been selected. To see the selected crane configuration, push the "INFO" Button (Please refer to ⇒ chapter 5.2.)

If the crane is equipped with a **luffing jib**, and the luffing jib is selected, the operating screen will additionally show the current luffing jib angle. This example shows a typical operating screen for luffing jib configuration:



Please note that the crane symbol does not reflect the crane configuration that has been selected. To see the selected crane configuration, push the "INFO" Button (Please refer to ⇒ chapter 5.2.)

As needed, further symbols can show on the display:

	<p>Symbol Anti Two-Block Alarm</p> <ul style="list-style-type: none"> • visible when the anti-two-block limit switch contacts open, indicating that a two-blocking condition is approaching.
	<p>Symbol Slewing Angle Limitation:</p> <ul style="list-style-type: none"> • continuously visible: <i>Slewing Angle Limitation active</i> • blinking: <i>Slewing Angle Limits exceeded</i> (⇒ see chapter 5.1.1.a)
	<p>Symbol Virtual Wall:</p> <ul style="list-style-type: none"> • continuously visible: <i>Virtual Wall active</i> • blinking: <i>Virtual Wall limits exceeded</i> (⇒ see chapter 5.1.1.b)
	<p>Symbol height limitation:</p> <ul style="list-style-type: none"> • continuously visible: <i>height limitation active</i> • blinking: <i>height limit exceeded</i> (⇒ see chapter 5.1.2)
	<p>Symbol boom angle limitation:</p> <ul style="list-style-type: none"> • continuously visible: <i>boom angle limitation active</i> • blinking: <i>Boom angle limits exceeded</i> (⇒ see chapter 5.1.3)
	<p>Symbol radius limitation</p> <ul style="list-style-type: none"> • continuously visible: <i>radius limitation active</i> • blinking: <i>Radius limits exceeded</i> (⇒ see chapter 5.1.4)
E####	<p>Error code No. #### (⇒ see chapter 8 "Troubleshooting")</p>

5.1 LIMIT Setting

The RCL system has been equipped with programmable limits for the crane's operation range.

- Easy programming due to interactive, step-by-step user guidance
- Functions can be used individually or in combinations.
- Exceeding a programmed limit triggers an audible and visual alarm.
- Depending on the crane type not all functions listed below may be available.
- The functions provide an audio-visual alarm when set limits are reached. They do not provide any function-kick-outs!

Overview limits:

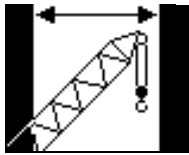

Radius Limitation
(⇒ chapter 5.1.1)

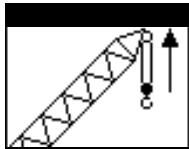

Tip Height Limitation
(⇒ chapter 5.1.2)

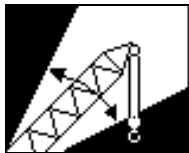

Boom Angle Limitation
(⇒ chapter 5.1.3)



Slewing Angle Limitation / Virtual Wall
(⇒ chapter 5.1.4)

5.1.1 Radius Limitation

This function allows the operator to program an audible and visual alarm for the limitation of a minimum and/or maximum working radius.

➡ To set / delete radius limit:

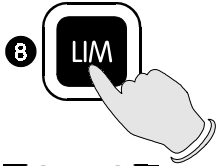

Call LIMIT Setting

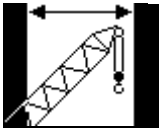

Select the corresponding symbol to call the function "Radius Limitation".

Screen will now show:

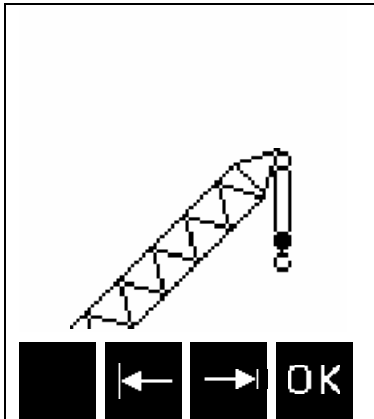

You have the choice to:

- Set a minimum radius limit:
- Set a maximum radius limit:
- Exit the function without any changes:

If a limit has already been set, it will be shown as blacked-out area with the set value(s) for radius limit:

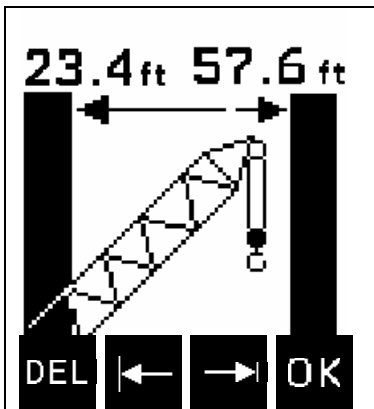

You have the choice to:

- Change the minimum radius limit:
- Change the maximum radius limit:
- Exit the function without any changes:
- Delete the radius limits and exit the function:

➤ To set / delete minimum radius limit:

Screen shows (with current radius value):

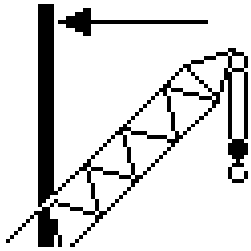

To set:

Position boom at the desired minimum radius.

Push **SET** to set current working radius as minimum radius limit.

To delete:

Push **DEL** to delete minimum radius limit and exit the function.

This takes you back to the previous screen, "Set / Delete Radius Limits":

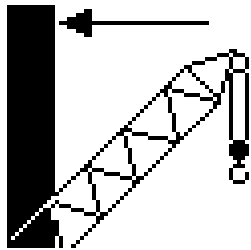

Screen now shows symbol with a black bar to the left and the set value for min. radius limit, if you have set one.

(If you did not set a minimum radius limit, there will be no left black bar and no radius value displayed).

Pushing **OK** will accept setting and quit function.

➤ To set / delete maximum radius limit:

Screen shows (with current radius value):

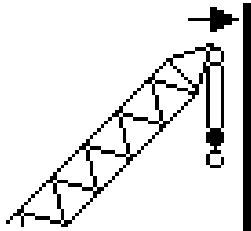

To set:

Position boom at the desired maximum radius.

Push **SET** to set current working radius as maximum radius limit.

To delete:

Push **DEL** to delete maximum radius limit and exit the function.

This takes you back to the previous screen, "Set / Delete Radius Limits".

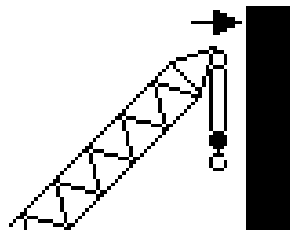

Screen now shows symbol with a black bar to the right and the set value for max. radius limit, if you have set one.

(If you did not set a maximum radius limit, there will be no right black bar and no radius value displayed).

Pushing **OK** will accept setting and quit function.

5.1.2 Tip Height Limitation

This function allows the operator to program an audible and visual alarm for the limitation of the tip height.

➔ To set / delete tip height limit:

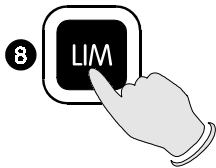

Call LIMIT Setting

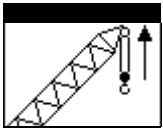

Select the corresponding symbol to select function "Tip Height Limitation".

Screen will now show:

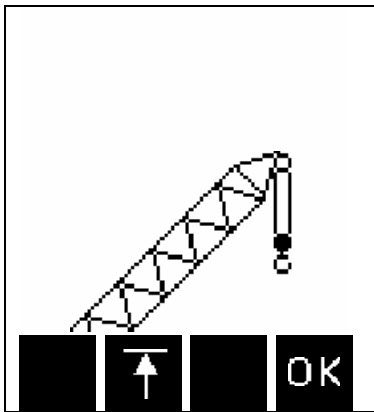

You have the choice to:

- Set a tip height limit:
- Exit the function without any changes:

If a limit has already been set, it will be shown as blacked-out area with the set value for tip height limit.

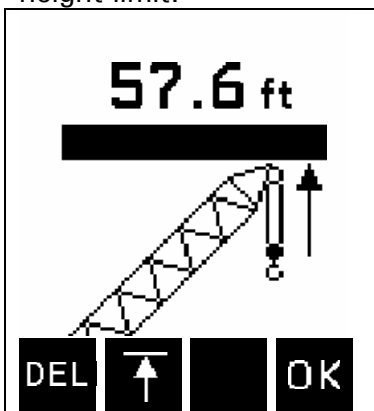

You have the choice to:

- Change the tip height limit:
- Exit the function without any changes:
- Delete the tip height limit and exit the function:

➤ **To set / delete tip height limit:**

Screen shows (with current tip height value):

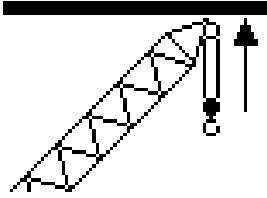

To set:

Position boom at the desired tip height value.

Push **SET** to set current tip height as tip height limit.

To delete:

Push **DEL** to delete tip height limit and exit the function.

This takes you back to the previous screen, "Set / Delete Tip Height Limits":

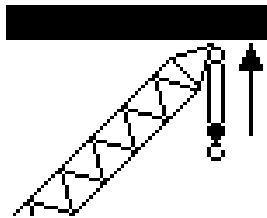

Screen now shows symbol with a black bar and the set tip height limit value, if you have set one.

(If you did not set a tip height limit, there will be no black bar and no tip height value displayed).

Pushing **OK** will accept setting and quit function.

5.1.3 Boom Angle Limitation

This function allows the operator to program an audible and visual alarm for the limitation of the upper and/or lower boom angle.

➔ To set / delete boom angle limits:

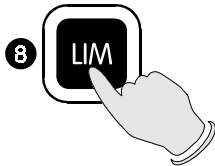

Call LIMIT Setting

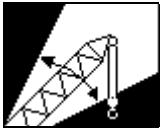

Select the corresponding symbol to call the function "Boom Angle Limitation".

Screen will now show:

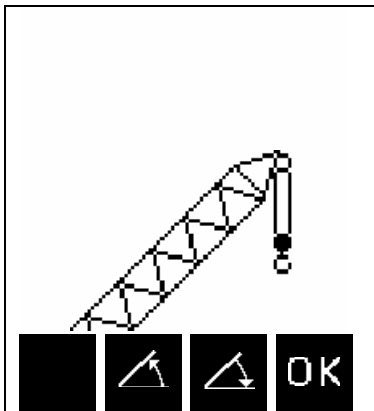

You have the choice to:

- Set a maximum (upper) boom angle limit:
- Set a minimum (lower) boom angle limit:
- Exit the function without any changes: **OK**

If a limit has already been set, it will be shown as blacked-out area with the set value(s) for radius limit:



You have the choice to:

- Set a maximum (upper) boom angle limit:
- Set a minimum (lower) boom angle limit:
- Exit the function without any changes: **OK**
- Delete the angle limits and exit the function: **DEL**

➤ To set / delete maximum boom angle limit:

Screen shows (with current boom angle value):

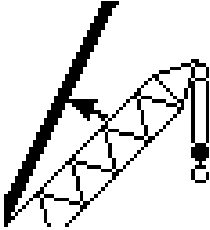

To set:

Position boom at the desired maximum boom angle.

Push **SET** to set current boom angle as maximum boom angle limit.

To delete:

Push **DEL** to delete maximum boom angle limit and exit the function.

This takes you back to the previous screen, "Set / Delete Boom Angle Limits".

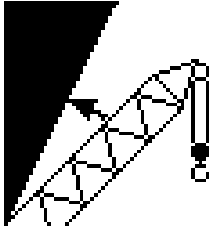

Screen now shows symbol with a black bar in the upper left corner and the set value for max. boom angle limit, if you have set one.

(If you did not set a maximum boom angle limit, there will be no upper left black bar and no boom angle value displayed).

Pushing **OK** will accept setting and quit function.

➤ To set / delete minimum (lower) boom angle limit:

Screen shows (with current boom angle value):

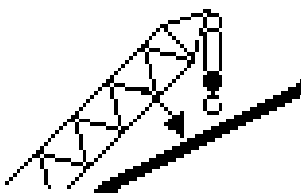

To set:

Position boom at the desired minimum boom angle.

Push **SET** to set current boom angle as minimum boom angle limit.

To delete:

Push **DEL** to delete minimum boom angle limit and exit the function.

This takes you back to the previous screen, "Set / Delete Boom Angle Limits":

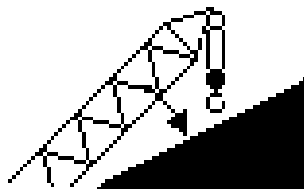

Screen now shows symbol with a black bar in the lower right corner and the set boom angle value for min. boom angle limit, if you have set one.

(If you did not set a minimum boom angle limit, there will be no lower right black bar and no boom angle value displayed).

Pushing **OK** will accept setting and quit function.

5.1.4 Slewing Angle Limitation / Virtual Wall Definition

Programmable function for the limitation of the left and/or right slewing angle or virtual wall definition.

➔ To call function:

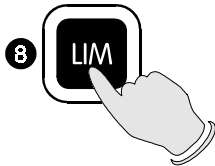

Call LIMIT Setting



Select the corresponding symbol to call the slewing limit functions "Slewing Angle Limitation" or "Virtual Wall".

Now, select one of the following:



1 Function "Slewing Angle Limitation" to set a minimum/maximum slewing angle (⇒ *chapter 5.1.1.A*)



2 Function "Virtual Wall" to set a Virtual Wall (⇒ *chapter 5.1.1.B*)

5.1.4.A Slewing Angle Limitation



This function allows the operator to set a left and a right slewing angle limit. Both limits have to be set for the function to be activated, but it does not matter which one is set first.

☛ To set / delete slewing angle limits:

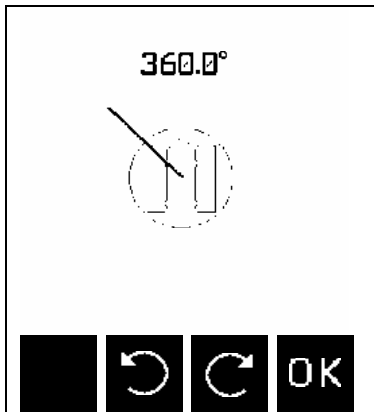
Screen will now show (no slewing limits set yet):





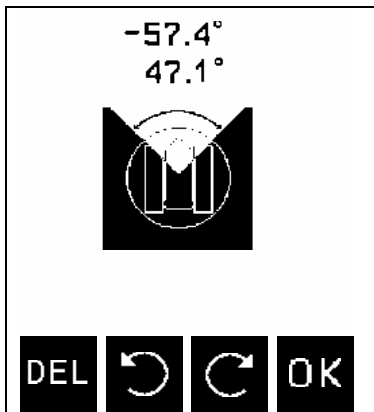

You have the choice to:

- Set a left slewing angle limit: 
- Set a right slewing angle limit: 
- Exit the function without any changes: 

If limits have been set already, they will be shown as a blacked-out area with the set values for left and right slewing angle limit:



You have the choice to:

- Change the left slewing angle limit: 
- Change the right slewing angle limit: 
- Exit the function without any changes: 
- Delete the angle limits and exit the function: 

➤ **To set / delete left slewing angle limit:**

Screen shows (with current slewing angle value):

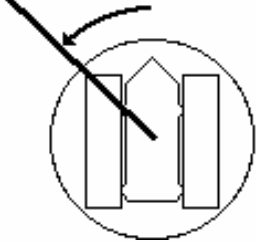

To set:

Swing boom to the desired left slewing angle.

Push **SET** to set current slewing angle as left slewing angle limit.

To delete:

Push **DEL** to delete left slewing angle limit and exit the function.

This takes you back to the previous screen, "Set / Delete Slewing Angle Limits":

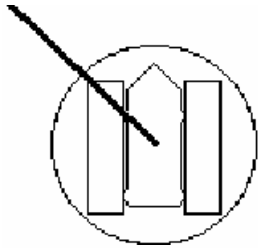

Screen now shows symbol again with the set slewing angle value for left slewing angle limit, if you have set one.

Pushing **OK** will accept setting and quit function.

Pushing **DEL** will delete limits and quit function.

➤ **To set / delete right slewing angle limit:**

Screen shows (with current slewing angle value):

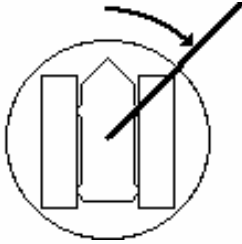

To set:

Swing boom to the desired right slewing angle.

Push **SET** to set current slewing angle as right slewing angle limit.

To delete:

Push **DEL** to delete right slewing angle limit and exit the function.

This takes you back to the previous screen, "Set / Delete Slewing Angle Limits".



Screen now shows symbol with a blacked-out area and the set values for slewing angle limit, if you have set them.

(If you did not set a slewing angle limits, there will be no black area and no slewing angle values displayed).

Pushing **OK** will accept setting and quit function.

Pushing **DEL** will delete limits and quit function.

5.1.4.B Virtual Wall Limit

The *virtual wall limit* allows the operator to define a vertical wall that can represent obstacles (i.e. buildings, towers, poles, etc.) in the crane's working range. The wall is set by defining points with the boom tip within a safe working distance from the obstacle, see setup procedure below. Because these walls are defined by the operator and are not actual/real walls, we refer to them as "virtual" walls. **When setting the walls, always keep a safe working distance to any obstacles. Never work outside a safe working area as outlined by common practice, standards, and manuals.**

A *virtual wall* is set by defining two points. To prevent inaccuracies when defining the two points for the virtual wall, use the following to rules:

1. *The two points should be at the same distance from the obstacle.*
2. *Set the two points at the maximum distance apart, which can be safely reached by the boom tip.*

The operator can set up a virtual wall and trim or remove part of the wall to best define the obstacle. The wall is defined by a straight line between two set points and then can be trimmed by positioning the boom tip at a point near the wall and removing part of the wall to the left or right of the boom. After the walls have been set, the system alerts the operator when the boom approaches them. This is done both visual and audible. The console will warn the operator by an audible, beeping alarm, which increases in frequency as the boom approaches the wall. At the same times, the control light "Alarm Stop" (refer to no. 6, chapter 3.3 of the operator's manual) will come on and the button "LIM" (refer to no. 8, chapter 3.3 of the operator's manual) will be lit. Similarly, the "virtual wall" symbol in the main screen blinks. If the boom crosses the wall the audible alarm becomes continuous.



THERE ARE NO CUTOUTS ASSOCIATED WITH THE VIRTUAL WALL FEATURE.

➤ Virtual Wall Creation Screen

The virtual wall creation screen displays the following:

- the pointed end of the crane symbol indicates the front of the crane
- the boom is indicated by a line drawn from the center of the crane symbol
- the length of the line (boom) indicates the crane's operating radius

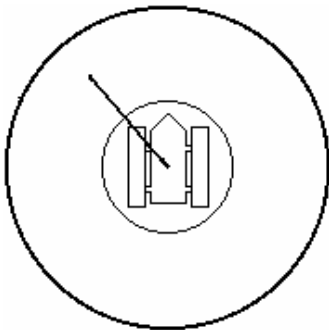

Select the preferred action.



Select to create a virtual wall.



Accepts a previous defined walls and exits.



Press  to create a virtual wall.

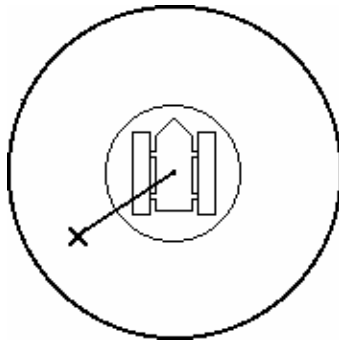

A wall is defined by a straight line between two set points. A blinking X indicates that a point may be set to define a wall. Move the boom tip to one end of the virtual wall at a safe distance from the obstacle, press 'SET'.

Warning: Never work outside a safe working area as outlined by common practice, standards, and manuals.

DEL

Deletes all virtual wall settings and returns to the operating screen.

SET

Sets a point in the working area to start a wall.

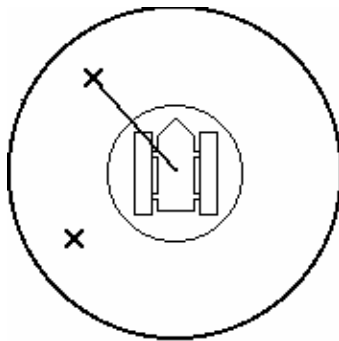

Having pressed SET, the X is displayed (without blinking) at this point. Move the boom to the second point at a safe distance from the obstacle. This point should be the maximum distance from the first point that can be safely reached by the boom tip. The blinking X at the boom tip indicates that the second point may be set to define the wall. Press 'SET'.

Warning: Never work outside a safe working area as outlined by common practice, standards, and manuals.

DEL

Deletes all virtual wall settings and returns to the operating screen.

SET

Sets a point in the working area to start a wall.

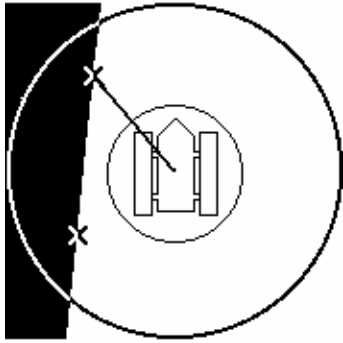

After pressing SET, an infinite virtual wall is defined. Now, three soft keys are available



Deletes all virtual wall settings and returns to the operating screen.



Deletes existing wall and returns to the virtual wall creation screen.



Accepts the defined wall **and** enters the wall editing screen.

➔ **VIRTUAL WALL EDITING SCREEN**

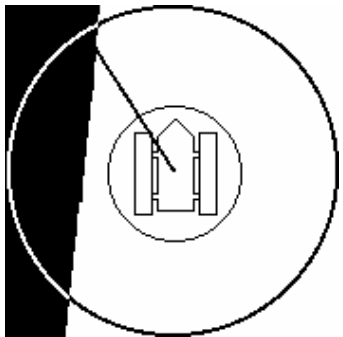

Deletes all virtual wall settings and returns to the operating screen.



Deletes existing wall and returns to the virtual wall creation screen.



Allows the operator to edit the virtual wall by trimming or creating a corner in the wall.



Accepts the defined walls and exits to operating screen.

After pressing the edit button , the following four displays show how to edit the wall.

➤ **Trimming/Removing the wall to the right of the boom:**

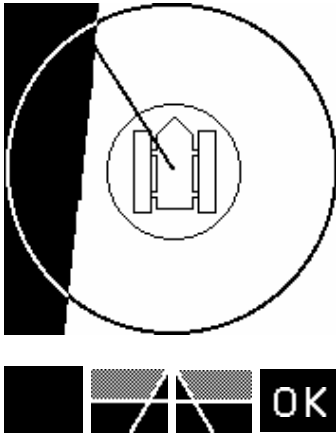

Edits the wall by trimming/removing the wall to the right of the boom



Edits the wall by trimming/removing the wall to the left of the boom.



Accepts the defined walls and returns to the editing screen.



Press  to trimming/removing the wall the right of the boom.

After moving the boom to safe distance from the obstacle, press 'SET'.

Warning: Never work outside a safe working area as outlined by common practice, standards, and manuals.

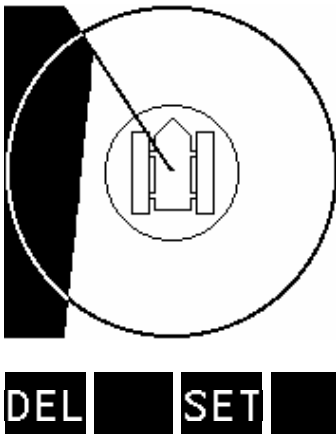

Returns to the editing screen



Sets the trim position and brings up the following edit screen

↻ Trimming / Removing the wall to the left of the boom

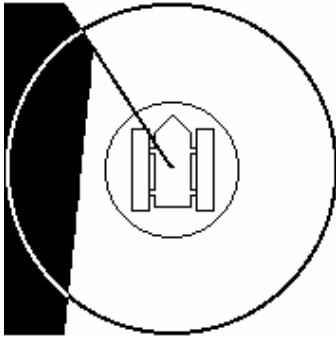
**DEL**

Returns to the previous screen



Edits the wall by trimming the wall to the right of the boom.



Edits the wall by trimming the wall to the left of the boom.

OK

Accepts the defined walls and exits

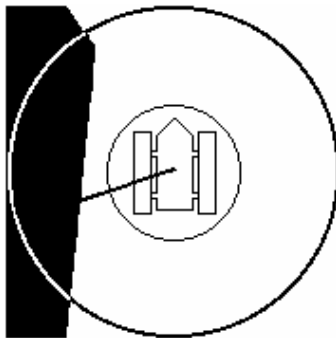
Press  for trimming/removing the wall to the left of the boom.**DEL**

Returns to the editing screen

SET

Sets the trim position and brings up the following edit screen

After moving the boom to safe distance from the obstacle, press 'SET'.

Warning: Never work outside a safe working area as outlined by common practice, standards, and manuals.

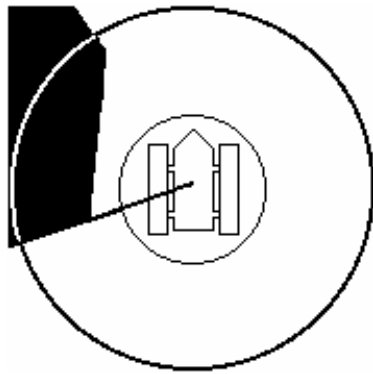

DEL

Deletes all virtual wall settings and returns to the operating screen.



Deletes existing wall and returns to the virtual wall creation screen.



Allows the operator to edit the virtual wall by trimming or creating a corner in the wall.

OK

Accepts the defined walls and exits to operating screen.

5.2 INFO crane configuration

With the system being ready for operation, this function serves to display the system configuration

- **Call function**

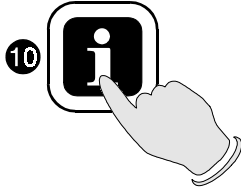

Press key "INFO".

Example:

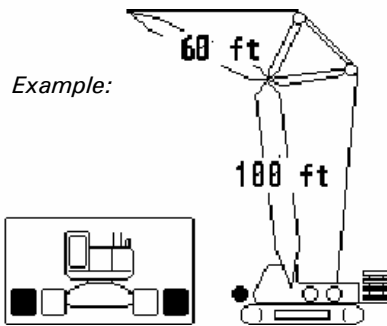

The display shows the crane symbol representing

- the selected boom configuration (here: main boom 100 ft plus luffing jib 60 ft),
- the adjusted configuration (marked black), i.e. counter weight selection, hoist drum selection and track position and the extended operating code.

To confirm the hoist selection, please use the function "set operating mode" (button "SELECT") ⇒ chapter 4.1, plus the function "Hoist-in-use quick selection" ⇒ chapter 4.2

- **End function**

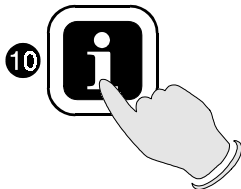

Press again key "INFO".

5.3 Display Contrast Control

This function allows for the contrast adjustment of the LC display. The last adjustment is stored and will be recalled at every system start.

➤ Contrast adjustment

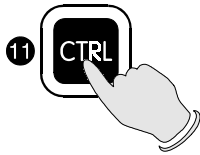

Press "CTRL".

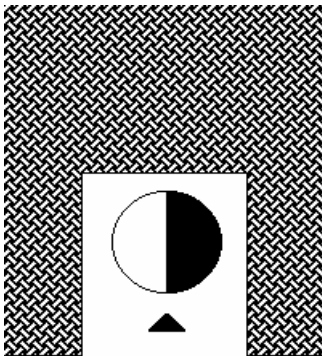

A pattern is shown which helps setting the display to the optimum contrast. Use the functional keys to modify the contrast upon request:

-  darken display
-  brighten display
-  confirm setting

Press key "OK" to store the momentarily adjusted contrast value and to quit the function.

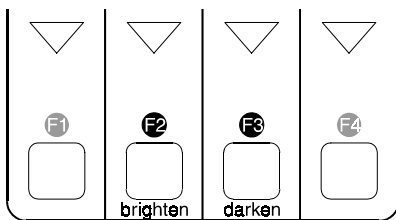

During normal RCL operation the display contrast can be adjusted too by pressing button:

F2 (darken display) or F3 (brighten display).

6 PRE-OPERATION INSPECTION AND CALIBRATION VERIFICATION

Before operating the crane, the following electrical connections must be checked to ensure that the system is properly connected for the crane configuration.

Machines with only a Main Hoist

If the crane works only with the boom and without boom extension, no additional connections are necessary. However, be sure the weight of the anti two-block switch is properly installed on the main hoist load line. With even parts of hoisting line, the weight shall be attached to the dead-end line. With odd parts of hoisting line, the weight shall be attached to the line of lowest speed.

If the crane works with boom extension, the connecting cable shall be installed between the junction box on the boom extension and the boom junction box. The weight attached to the main hoist anti two-block switch shall be removed. In that case the anti two-block switch has to be locked with the red Anti Two-Block Retainer, which is fixed with a red lanyard at the anti two-block switch (described on pages 40 and 41). Then the weight shall be reattached to the boom extension anti two-block switch.



Failure to re-position the anti two-block switch weight will prevent the over hoist system from functioning properly. No weight shall be on the main hoist anti two-block switch when the boom extension is being used.

Machines with Main and Auxiliary Hoists

If the boom extension is not in the operating position, the by-pass plug shall be installed in the main boom junction box. The weight of the main hoist anti two-block switch shall be installed.

If the boom extension is in the operating position, the connecting cable shall be installed between the junction boxes on the boom extension and the main boom. Weights shall also be attached to the anti two-block switches on both the main boom and boom extension.

If the boom extension is in the operating position and no load line is being used on main boom, to prevent injury or damage to equipment, the weight shall be removed from main boom switch. In that case the anti two-block switch has to be locked with the red Anti Two-Block Retainer, which is fixed with a red lanyard (not shown) at the anti two-block switch.

Installation of Anti Two-Block Retainer in Locking Position

Procedure (see Fig. 1 and 2):

1. Pull the cable out of the switch and bend back parallel to the boom and hold (1).
2. Slide the retainer from left side with its slot over the cable between the crimped stop and the switch (2). Push it firmly straight onto the cable guide of the Anti Two-Block switch (3).

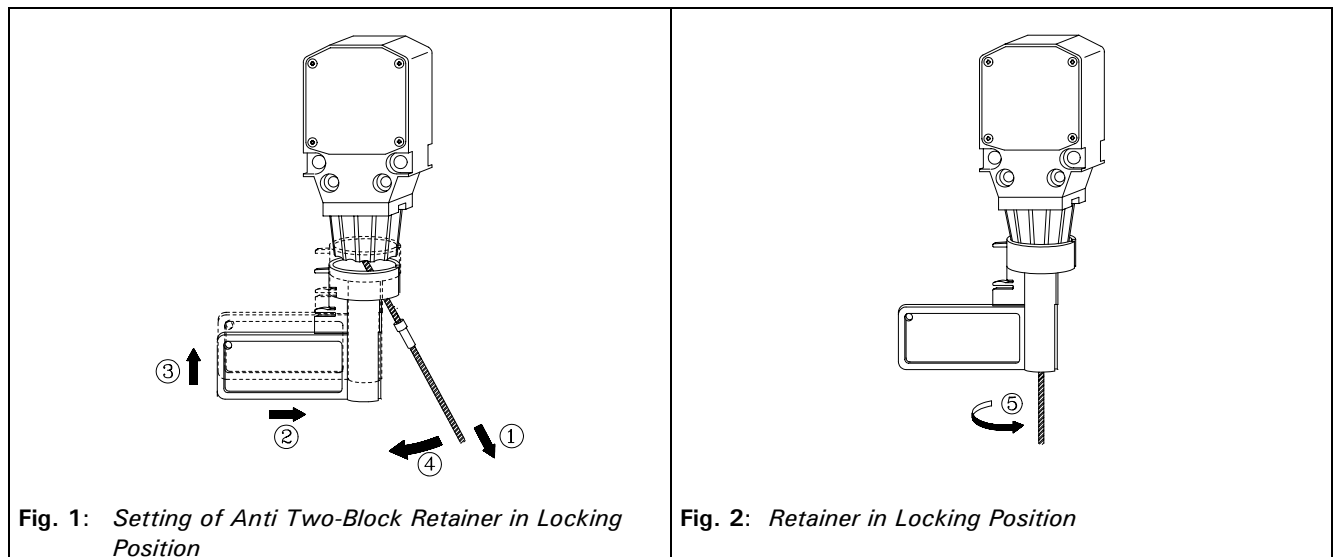

3. Straighten the cable completely into the slot and release the cable (4).
4. Turn the flag of the retainer for best visibility for the operator (5).

Removal and Storage of the Anti Two-Block Retainer

Procedure (see Fig. 3 and 4):

1. Pull the cable out of the switch (1) and bend back parallel to the boom and hold (2).
2. Move the retainer down (3) and then left (4) to remove it from the Anti Two-Block switch. Release the cable.
3. For storage slide the retainer from right side (5) over the Anti Two-Block switch until the clips (A) lock into the holes (B).

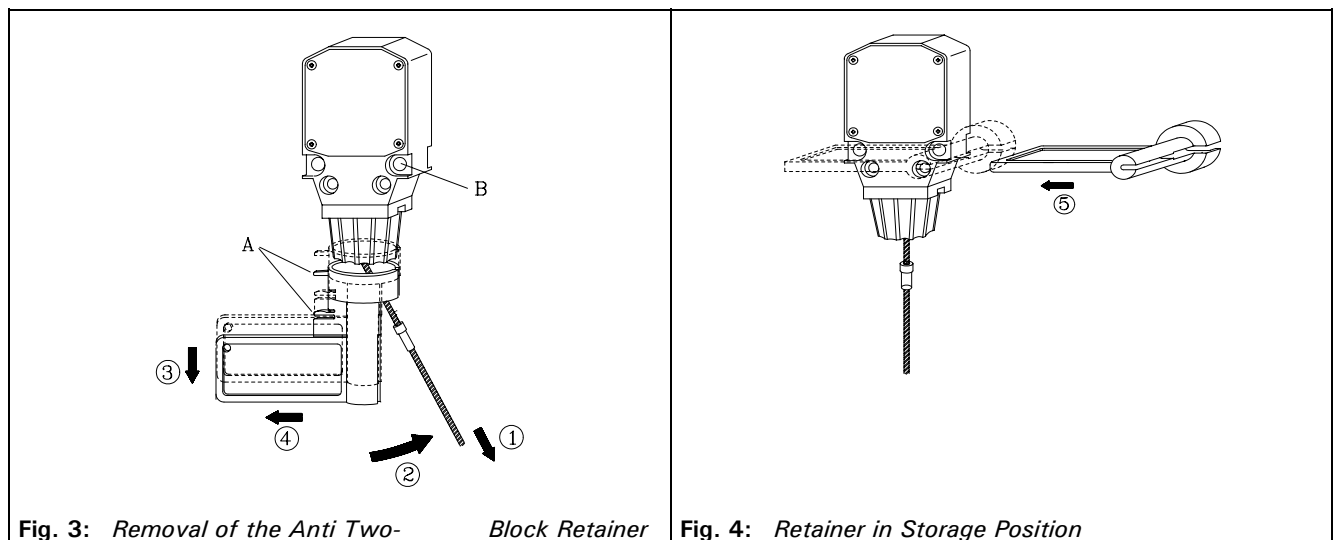

Pre-Operation Inspection and Calibration Verification

After the electrical connections have been checked to insure that the system is properly connected for the crane configuration, the following checks shall be made:

1. Check the electrical wiring connecting the various parts of the system for physical damage.
2. Check the anti two-block switches and weights for free movement.



The following tests shall be performed with care to prevent damage to the machine or injury to personnel. Proper functioning of the system requires successful completion of these tests before operating the machine.

If the operator cannot see the load-handling device approaching the boom nose, he shall have an assistant (signal person) watch the load-handling device. The operator shall be prepared to stop the machine immediately should the RCL system not function properly as indicated by lighting the red warning light (4), sounding the audible alarm (12) and locking the crane movements, hoist up, telescope out and boom down.

3. Check the anti two-block alarm light (4) and the audible alarm (12) by performing one of the following tests:
 - a. By manually lifting the weight attached to the anti two-block switches. When the weight is lifted, the audible alarm (12) should sound, the anti two-block alarm light (4) should light.
 - b. Slowly raise the main boom load-handling device to create a potential two-block condition. When the load-handling device lifts the weight, the audible alarm (12) should sound, the anti two-block alarm light (4) should light and the motion of the load-handling device should be stopped. Lower the load-handling device slightly to eliminate this condition.
 - c. Slowly lower the boom to create a potential two-block condition. When the load-handling device lifts the weight, the audible alarm (17) should sound, the anti two-block alarm light (24) should light and the boom lowering function should be stopped. Lower the load-handling device slightly to eliminate this condition.



If the light and audible alarm do not function as described and the crane movements are not stopped, the system is not working properly. The malfunction shall be corrected before operating the crane.

4. If the crane is equipped with a boom extension, repeat the test procedure for the boom extension anti two-block switch.
5. Check that the display of the main boom length agrees with the actual boom length.
6. Check that the display of the main boom angle agrees with the actual boom angles.
7. Check that the display of the operating radius of the crane agrees with the actual radius.
8. Check the load display by lifting a load of known weight.

Operation

Upon correct inspection the RCL is operational. The operator shall be thoroughly familiar with all controls of the RCL before operating the crane. The proper function of the system shall be checked by lifting a load of known weight and comparing the load to the information displayed on the RCL.

Rated loads include the weight of the hook block, slings, and auxiliary load handling devices. Their combined weights shall be subtracted from the listed load capacities as stated on the load capacity chart to obtain the net load to be lifted.



If any of the displays reflects a deviation between displayed and actual values, an authorized PAT service representative shall be called for repair of the system or re-verification of the crane's RCL calibration.



Any structural modifications or changes to the crane shall require re-verification of the crane's RCL calibration.

7 SERVICE AND MAINTENANCE

Daily maintenance of the Rated Capacity Limiter consists of inspecting:

1. The electrical wiring connecting the various parts of the system.
If electrical wiring is damaged, it shall be replaced immediately.
2. If the insulation is worn on the electrical wiring or cable guides are damaged, these parts shall be replaced.
3. Check the anti two-block limit switches for freedom of movement.

Other than correcting the problems identified in the Malfunctions Table and replacing faulty mechanical parts and cables, no other repairs shall be performed by non-expert personnel.

8 TROUBLESHOOTING

General

In case of a malfunction of the system, the display (1) will indicate a code that identifies the system malfunction.

The error codes listed in the Malfunction Table will identify various faults that can occur with the RCL. Following the Malfunction Table are pages, which explain each fault and describe the action, which shall be taken to correct the fault.

Faults within the electronic microprocessor shall be repaired by factory trained service personnel. When these faults occur, the competent service organization shall be contacted.

Malfunction Table

<i>Error Code</i>	<i>Error</i>
E01	Fallen below the radius or above angle range
E02	Radius range exceeded or fallen below angle range
E03	Boom position is out of the permissible working area
E04	Operating mode not existing
E05	Prohibited length range

NOTE:

If there is any Error Code displayed on the console, which is not listed in the Malfunctions Table, you shall call the Local Distributor.

Operating Errors

Malfunctions in the system, which are caused by, range exceeding or operating errors by the crane operator himself are indicated on the display together with an explanation. These error codes are E01, E02, E03, E04, (E05) and they can normally be eliminated by the crane operator himself.

Error Code	Cause	Elimination
E01	Fallen below the minimum radius or above the angle given in the load capacity chart due to luffing up the boom too far.	Boom down to a radius or angle given in the load capacity chart.
E02	The maximum radius or minimum angle given in the load capacity chart was exceeded due to luffing down the boom too far.	Boom up to a radius or angle given in the load capacity chart.
E03	Boom position is out of the permissible working area (over front).	Move boom back to the permissible working area. See lifting diagram in the load capacity charts.
E04	Operating mode switch in the console incorrectly set.	Correctly set operating mode switch to the code assigned to the operating mode of the crane.
	Operating mode is not permissible with the actual crane configuration, boom position or area definition.	Be sure crane is set up according to proper operating configurations.

Appendix A: Detailed symbol explanation of boom extensions



*main boom
(Tube or Angular
Boom)*

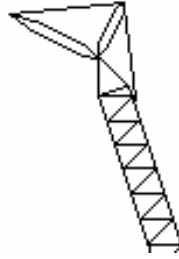

Fixed jib operation



*main boom
with tip
extension
("Horse Head")*

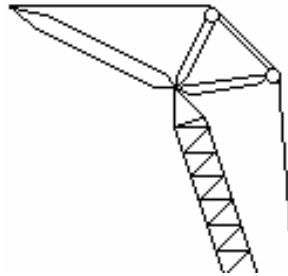

luffing jib operation



*main boom
with
hammerhead*

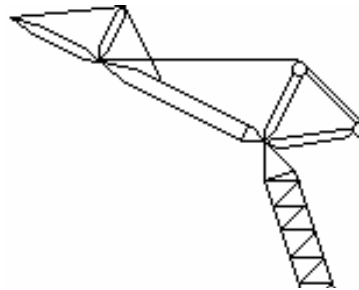

*luffing jib + fixed jib
operation*



*main boom
with
hammerhead
and extension*

Appendix B: Detailed symbol explanation of counter weight options

Option

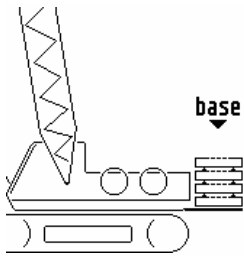

+ increase counterweight
OK confirm counterweight

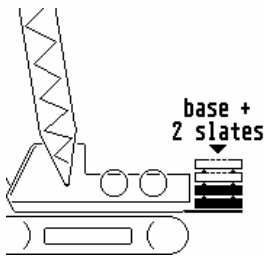

- decrease counterweight
+ increase counterweight
OK confirm counterweight

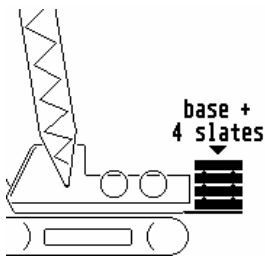

- decrease counterweight
+ increase counterweight
OK confirm counterweight

Option



- decrease counterweight
+ increase counterweight
OK confirm counterweight