

**PAT
LOAD MOMENT
INDICATOR
DS 350
INTERACTIVE**

OPERATOR'S HANDBOOK

NOTICE

The information in this document is subject to change without notice.

PAT makes no warranty of any kind with regard to this material, including, but not limited to, the implied warranties of merchantability and fitness for a particular purpose.

PAT shall not be liable for errors contained herein or for incidental or consequential damages in connection with the furnishing, performance, or use of this manual.

This document contains proprietary information which is protected by copyright. All rights are reserved. No part of this document may be photocopied, reproduced, or translated to another language without the prior written consent of PAT.

TABLE OF CONTENTS

1	General Information	1
<hr/>		
2	Warnings	1
<hr/>		
3	System Description	3
3.1	System Function	5
3.2	Operating Console	5
3.3	Control Identification	5
<hr/>		
4	Programming procedure	19
4.1	Setting the Outrigger Configuration	20
4.2	Hoist Line Selection	20
4.3	Setting the Boom Configuration	21
4.4	Setting the Reeving	22
4.5	Confirmation of Programming Procedure	22
<hr/>		
5	Pre-Operation Inspection and Calibration Verification	23
<hr/>		
6	Service and Maintenance	29
<hr/>		
7	Troubleshooting	30
<hr/>		

1 GENERAL INFORMATION

The PAT Load Moment Indicator¹⁾ (LMI) DS 350 has been designed to provide the crane operator with the essential information required to enable the machine to be used within its design parameters.

Using various sensing devices, the Load Moment Indicator monitors various crane functions and provides the operator with a continuous reading of the crane's capacity. The readings continuously change as the crane moves through the motions needed to make the lift.

The LMI provides the operator with information regarding the length and angle of the boom, working radius, rated load and the total calculated weight being lifted by the crane.

If non permitted conditions are approached, the DS 350 Load Moment Indicator will warn the operator by sounding an audible alarm, lighting a warning light and locking out those functions that may aggravate the crane's condition

1) **LOAD MOMENT:** generally the product of a force and its moment arm; specifically, the product of the load and the load-radius. Used in the determination of the lifting capacity of a crane.

2 WARNINGS

The LMI is an operational aid which warns a crane operator of approaching overload conditions and also warns of overhoist conditions which could cause damage to equipment and personnel.

The device is not, and shall not, be a substitute for good operator judgement, experience and use of accepted safe crane operating procedures.

The responsibility for the safe operation of the crane shall remain with the crane operator who shall ensure that all warnings and instructions supplied are fully understood and observed.

Prior to operating the crane, the operator must carefully and thoroughly read and understand the information in this manual to ensure that he knows the operation and limitations of the indicator and crane.

Proper functioning is dependent upon proper daily inspection and observations of the operating instructions set forth in this manual. We draw your attention to section 5 of this handbook.

WARNING

The displays will only aid the operator when the LMI is properly programmed and the proper load capacity chart is selected for the crane configuration being utilized. To prevent property damage or serious bodily injury or death to personnel, ensure the LMI is properly programmed before operating the crane.

3 SYSTEM DESCRIPTION

The PAT Load Moment Indicator DS 350 consists of a central micro processor unit, operating console, length/angle sensor, pressure transducers, and anti-two block switches.

The system operates on the principle of reference/real comparison. The real value, resulting from the pressure measurement is compared with the reference data, stored in the central processor memory and evaluated in the micro processor. When limits are reached, an overload warning signal is generated at the operator's console. At the same time, the dangerous crane movements, such as hoist up, telescope out and boom down, will be stopped.

The fixed data regarding the crane, such as capacity charts, boom weights, centers of gravity and dimensions are stored in memory chips in the central processor unit. This data is the reference information used to calculate the operating conditions.

Boom length and boom angle are registered by the length/angle sensor, mounted inside the cable reel which is mounted on the boom. The boom length is measured by the cable reel cable which also serves as an electrical conductor for the anti two-block switches.

The crane load is measured by pressure transducers attached to the piston and rod side of the lift cylinders.

Fig. 1: Components of PAT LMI System DS 350

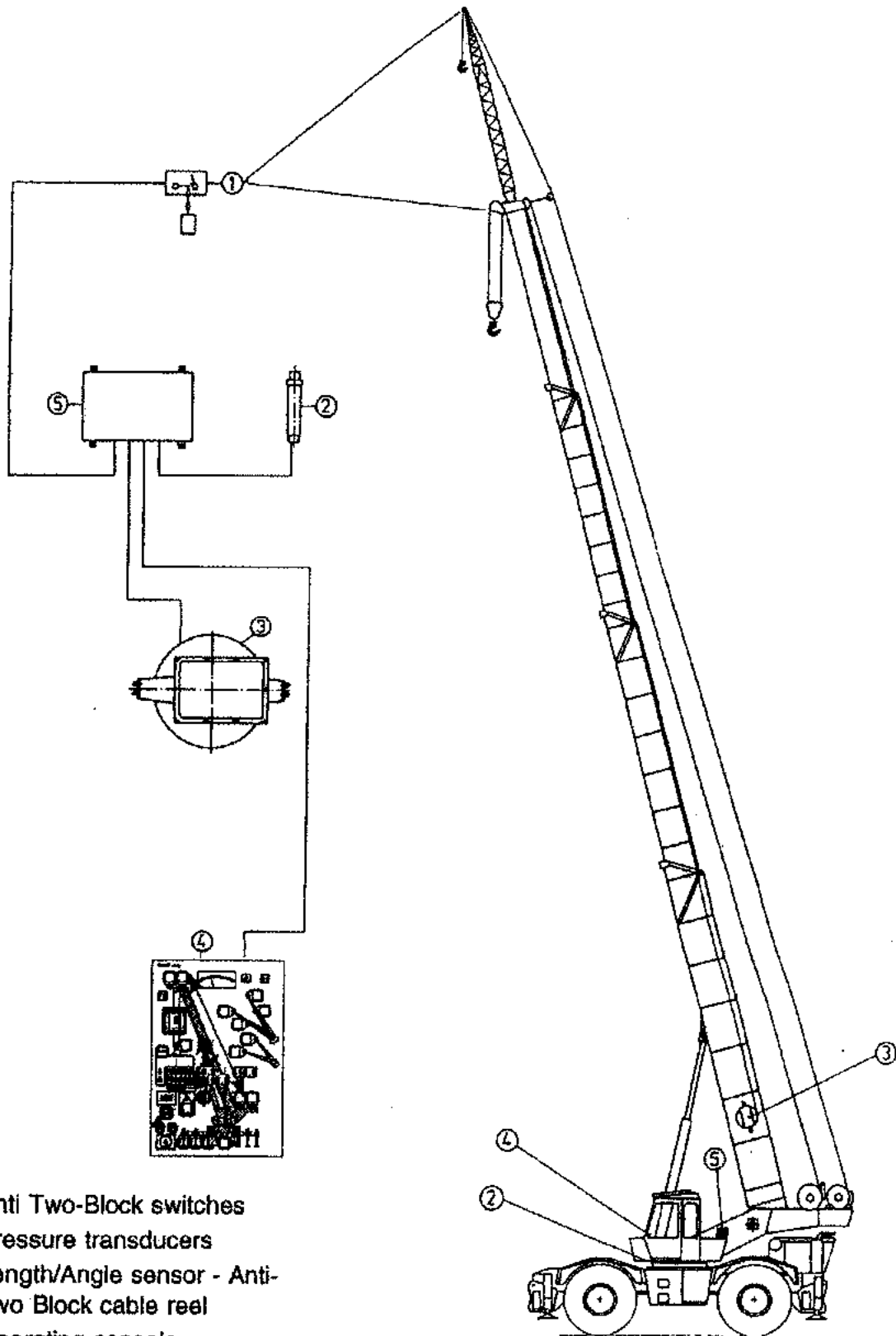

- 1 Anti Two-Block switches
- 2 Pressure transducers
- 3 Length/Angle sensor - Anti-Two Block cable reel
- 4 Operating console
- 5 Central-Micro-Processor unit

3.1 System Function

After ignition of the engine, the system starts with an automatic test of all lamps, the displays, the audible alarm and the complete system.

After the system has passed through the system test without errors, the system is ready for operation. The console will display actual load, load moment, boom length, boom angle, radius and crane data on the displays of the operating console (Fig.2).

In case of system's malfunction an error code number will also be displayed on the load display at the console.

3.2 Operating Console

The console has 2 functions:

- terminal for input of instructions to the system by the crane operator
- display of important data and information

The operating console is located in the operator's cabin in front of the operator. This unit contains different displays and controls which are described in chapter 3.3.

3.3 Control Identification

Figure 2 illustrates the controls and displays of the DS 350 Load Moment Indicator. The numbers of the illustration correspond to the numbers in the following list, which describes the function of each control.

Fig. 2: Operating Console

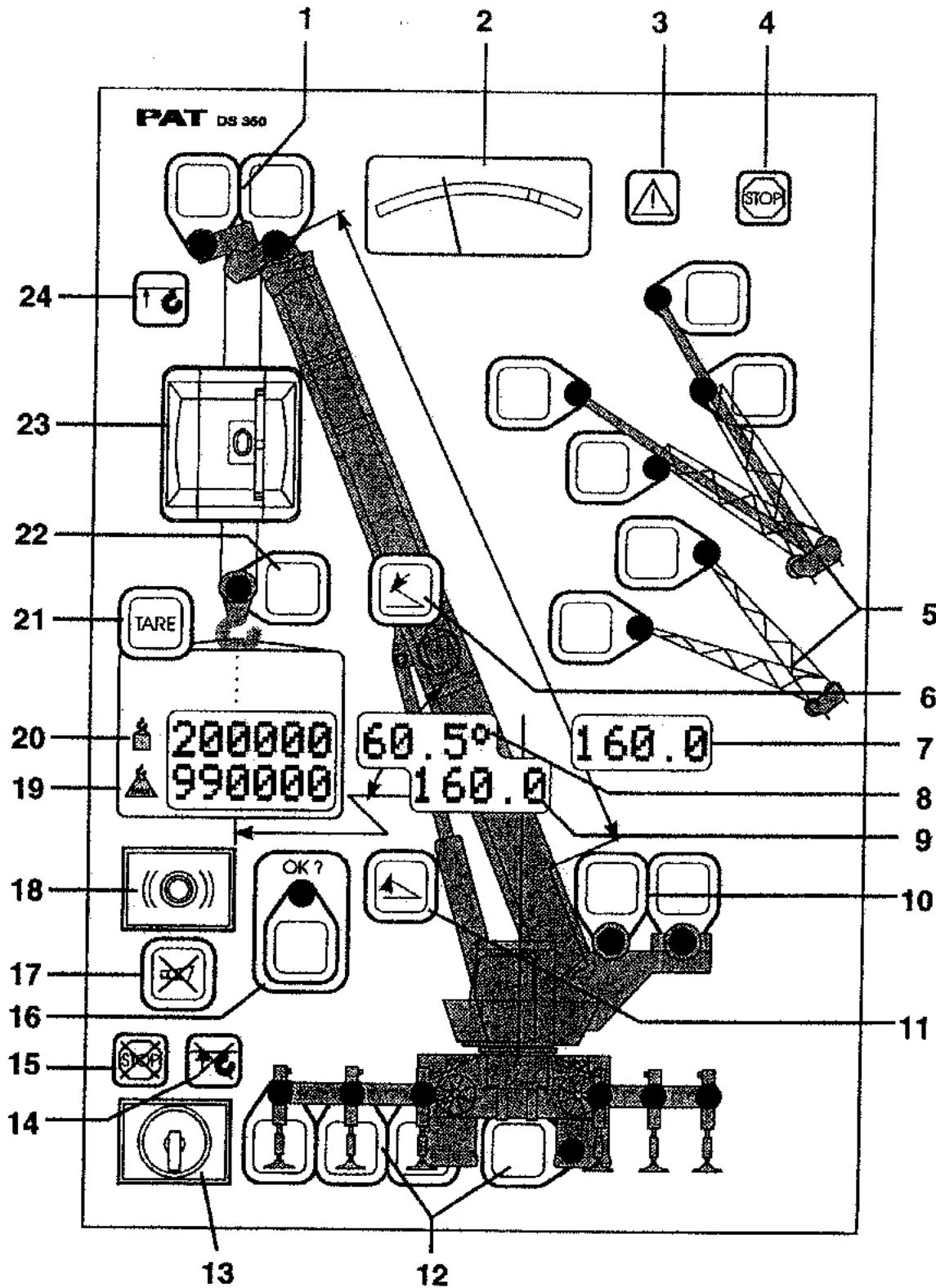

Legend to Fig. 2

- 1 Boom Nose Selection Buttons and Control Lights
- 2 Load Moment Indicator
- 3 Load Moment Prewarning Light
- 4 Load Moment Limit Light
- 5 Boom Extension Configuration Buttons and Control Lights
- 6 Button and Control Light "Upper Boom Angle Limit"
- 7 Boom Length Display
- 8 Boom Angle Display
- 9 Radius Display
- 10 Hoist Line Selection Buttons and Control Lights
- 11 Button and Control Light "Lower Boom Angle Limit"
- 12 Outrigger Configuration Buttons and Control Lights
- 13 By-Pass Key Switch
- 14 Control Light "Anti-2-Block Override"
- 15 Override Key Warning Light
- 16 Button "Confirmation of Programming Procedure"
- 17 Button "Alarm Stop"
- 18 Audible Alarm
- 19 Display "Maximum Load"
- 20 Display "Actual Load"
- 21 Button and Control Light "Tare"
- 22 Button and Control Light "Reeving Selection"
- 23 Reeving Switch
- 24 Anti Two-Block Alarm Light

1 Boom Nose Selection Buttons and Control Lights

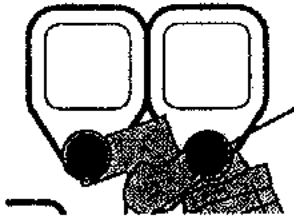

The two buttons (1) are used to provide the LMI with information regarding the actual boom nose configuration of the crane.

The control lights below the buttons are used to check the previously selected boom nose.

The setting of the buttons is part of the programming procedure, which is further described in chapter 4.3

WARNING

The correct setting is of utmost importance for the proper function of the system and the crane. Therefore only operators who are thoroughly familiar with crane load capacity charts and the use and operation of the system shall set the Boom Nose Configuration Buttons.

2 Load Moment Indicator



The load moment will be displayed in the INDICATOR (2). This meter displays how much of the crane's rated capacity is being used. As the crane is moved through its various motions, the percent of load moment will constantly change on the display.

The meter is divided into 3 areas:

- a green area is the normal working area
- a yellow prewarning area shows the remaining portion of the rated load capacity and the meter needle indicates the approach to the overload condition
- a red area shows that the maximum rated load capacity is exceeded.

Operating within the red area is not permitted.

3 Load Moment Prewarning Light



The yellow LOAD MOMENT PREWARNING LIGHT (3) will light up when the load on the crane enters the defined prewarning area. It indicates that an overload condition is approaching.

This means for the operator to continue his crane operation with extreme caution.

The definition and setting of the prewarning area is linked to the data EPROM used in the central unit.

4 Load Moment Limit Light



The red LOAD MOMENT LIMIT LIGHT (4) warns the operator that a rated load condition has been reached. It lights up when the load on the crane reaches the crane load capacity. The audible alarm also sounds when this condition has been reached.

The following crane movements will be stopped concurrently: hoist up, telescope out, boom up, boom down.

5 Boom Extension Configuration Buttons and Control Lights

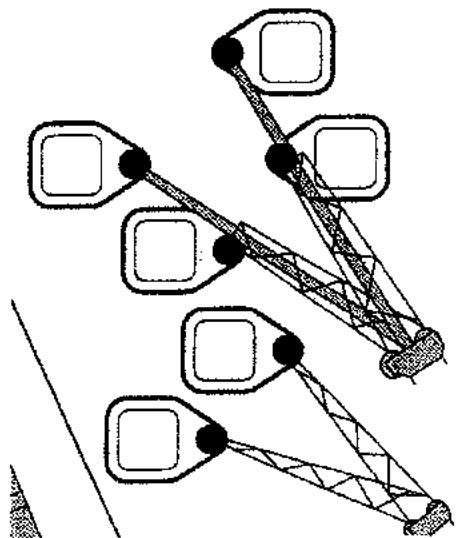

The Boom Extension Configuration Buttons (5) provide the LMI with information regarding the actually used boom extension configuration.

The selected boom extension configuration can be checked, as the respective lamp will light up.

The setting of the buttons is part of the programming procedure, which is further described in chapter 4.3

WARNING

The correct setting is of utmost importance for the proper function of the system and the crane. Therefore only operators who are thoroughly familiar with crane load capacity charts and the use and operation of the system shall set the Boom Extension Configuration Buttons.

6 Button and Control Light "Upper Boom Angle Limit"



This button (6) is used when the upper boom angle limit is requested.

To set the limit, the operator has to move the boom to the intended upper limit position and press the button (6). After pressing the button, the control light will light up indicating that the upper boom angle limit is activated.

Approaching boom angle limit will cause audible alarm and the Control Light "Upper Boom Angle Limit"(6) and the Load Moment Prewarning Light (3) to flash.

To reset the boom angle limits the two buttons "Upper Boom Angle Limit" (6) and "Lower Boom Angle Limit" (11) have to be pressed simultaneously.

7 Boom Length Display



This display shows the boom length.

8 Boom Angle Display

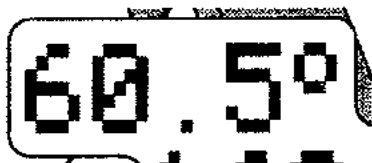

This display shows the boom angle to the horizontal line.

9 Radius Display



The Radius Display (9) shows the working radius of the crane.

10 Hoist Line Selection Buttons and Control Lights

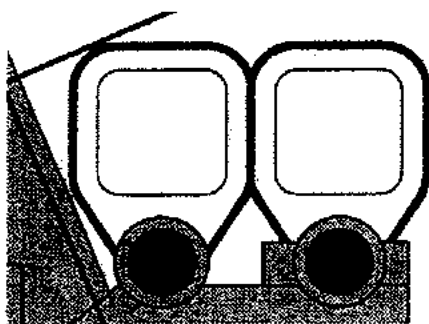

The Hoist Line Selection Buttons (10) provide the LMI with information regarding the used hoist line.

By means of the Hoist Line Control Lights, the crane operator can check the selected hoist line. The left lamp has to light up if the main hoist, the right lamp lights up if auxiliary hoist is used for lifting the load

The setting of the buttons is part of the programming procedure, which is further described in chapter 4.2.

WARNING

The correct setting is of utmost importance for the proper function of the system and the crane. Therefore only operators who are thoroughly familiar with crane load-capacity charts and the use and operation of the system shall set the Hoist Line Selection Buttons.

11 Button and Control Light "Lower Boom Angle Limit"

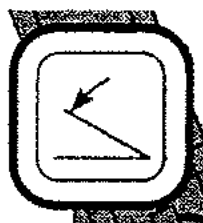

This button is used when the lower boom angle limit is requested.

To set the limit, the operator has to move the boom to the intended lower limit position and press the button (11). After pressing the button, the control light will light up indicating that the lower boom angle limit is activated.

Approaching boom angle limit will cause audible alarm and the Control Light "Lower Boom Angle Limit" (11) and the Load Moment Prewarning Light (3) to flash.

To reset the boom angle limits the two buttons "Upper Boom Angle Limit" (6) and "Lower Boom Angle Limit" (11) have to be pressed simultaneously.

12 Outrigger Configuration Buttons and Control Lights

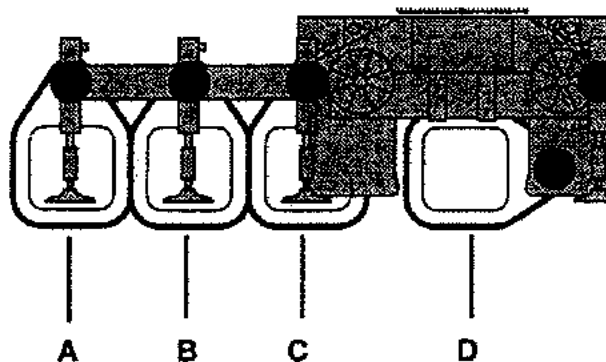

- A on outriggers, beams fully extended
- B on outriggers, beams in mid position
- C on outriggers, beams retracted
- D without outriggers, on rubber

The Outrigger Configuration Buttons (12) provide the LMI with information regarding the actually used outrigger configuration.

The selected outrigger configuration can be checked, as the respective lamp will light up.

The setting of the buttons is part of the programming procedure, which is further described in chapter 4.1.

WARNING

The correct setting is of utmost importance for the proper function of the system and the crane. Therefore only operators who are thoroughly familiar with crane load capacity charts and the use and operation of the system shall set the Outrigger Configuration Buttons.

13 By-Pass Key Switch

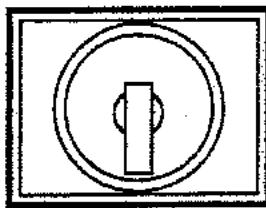

The BY-PASS KEY SWITCH (13) can deactivate the cut-off function of the LMI or anti-two-block momentarily to allow the crane operator to override the control lever lockout. It can be operated only by using the matching key.

The by-pass switch has 3 positions which are further described as follows:

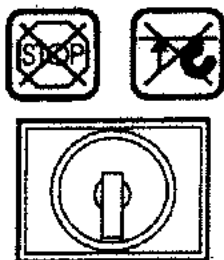

mid-position: In this position, the by-pass switch (13) is without influence to the LMI and anti-two-block control lever lockout.

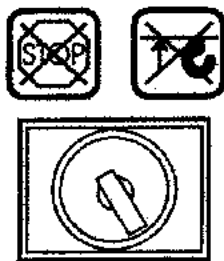

In this position (turn the key counter-clockwise), the by-pass key switch (13) deactivates the control lever lockout function of the LMI and of the anti two block. The Override Key Warning Light will blink. All other display, indicating and alarm functions will continue to work.

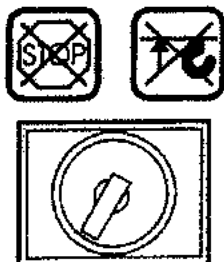

In this position (turn the key clockwise), the anti two-block control lever lockout is by-passed. This does not influence the LMI system.

WARNING

Since this switch deactivates the cut-off function of the LMI system and the anti two-block system, the following instructions shall be adhered to:

- the by-pass key shall be used with discretion, as unwarranted use of it to override the control lever lockout system can result in harm to the crane and danger to property and persons.
- never use the by-pass key to either overload or operate the crane in a range not permissible.

14 Control Light “Anti-2-Block Override”



This light (14) flashes to indicate that the cut-off function of the anti-two block system is deactivated.

15 Override Key Warning Light



The red OVERRIDE KEY WARNING LIGHT (15) flashes to indicate that the cut-off function of the LMI system is deactivated.

16 Button "Confirmation of Programm Procedure"

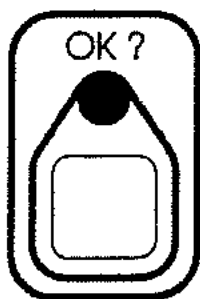

This button (16) has to be pressed for completion of the programming procedure.

After pressing the button, the control light will light up indicating that the programming procedure is completed and the system is in normal working condition.

The setting of the button (16) is part of the programming procedure, which is further described in chapter 4.5.

17 Button "Alarm Stop"



This ALARM STOP BUTTON (17) allows the audible alarm to be silenced for approximately 15 seconds by pressing this button. Reference "Audible Alarm" (18).

18 Audible Alarm



The AUDIBLE ALARM (18), which sounds during the following conditions:

- overload condition
- approaching two-block condition
- boom angle preset limits are reached
- in case of a malfunction of the LMI system
- in case of an operating error

The alarm can be silenced temporarily by pushing the button "Alarm Stop"(17).

19 Display "Maximum Load"



The Display (19) indicates the *maximum load*. Maximum load is the maximal permissible load according the number of parts of line selected by means of the Reeving Switch (23). Intermediate load values between two load chart points are calculated by means of linear interpolation by the computer.

20 Display "Actual Load"



During crane operation the readout (20) will display the "Actual Load". This is the actual load at the boom (gross load). Slings and hook block are included.

If boom extension is erected it will be reflected in the actual load displayed, however operator must use weight reduction values, shown in the load capacity chart.

After pushing the Button "Tare" (21), the Load Display (20) shows the "Net Load" (Reference #21).

In case of an operating error, the display shows an error code (Reference chapter 7)

21 Button and Control Light "Tare"



The button "Tare" (21) is used to indicate the "Net load" on the Load Display (20). *Net load* is the actual load, less lifting tackle and hook block. The TARE BUTTON (21) has to be activated before lifting.

After pushing the "Tare Button" (21) the load display is set to zero (taring) and the control light lights up. After lifting a load the load display shows the net load (pay load).

The net load display will change to the actual load display when the boom radius is changed (either by angle or length).

22 Button and Control Light "Reeving Selection"



The Button (22) has to be pushed for confirmation after setting the reeving switch (23) to the actual number of falls (parts of line).

The setting of the button (22) is part of the programming procedure, which is further described in chapter 4.4.

23 Reeving Switch

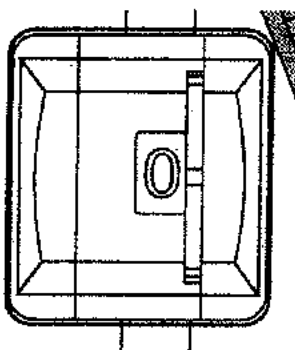

The "Reeving Switch" (23) provides the load moment indicator with information regarding the number of falls (parts of line) used to reeve the hook block.

The operator has to set the reeving switch to the actual number of falls (parts of line) being used.

The setting of the Reeving Switch (23) is part of the programming procedure, which is further described in chapter 4.4.

Caution

The correct setting of the Reeving Switch is of utmost importance for the proper function of the system and the crane. Therefore only operators who are thoroughly familiar with crane load capacity charts and the use and operation of the system shall set the Hoist Line Selection Buttons.

24 Anti Two-Block Alarm Light



The red "Anti Two-Block Alarm Light" (24) lights up when the anti-two-block limit switch contacts open, indicating that a two-blocking condition is approaching. At the same time the audible alarm will sound.

The following crane movements will be stopped subsequently: hoist up, telescope out, boom down.

4 Programming procedure

After each modification of the operating configuration of the crane, the crane operator has to set the Load Moment Indicator system to the new conditions.

Caution

The correct setting is of utmost importance for the proper functioning of the system and the crane. Therefore, only operators who are thoroughly familiar with the crane's load charts and the operation of the system should execute the setting of the system according the operating configuration of the crane.

The programming procedure is always started automatically after ignition of the engine.

During normal operation of the system and after a modification of the operating configuration of the crane, the programming procedure will be started, when one of the buttons on the console is pressed.

The programming procedure consists of the following steps:

- setting the outrigger configuration (yellow buttons)
- hoist line selection (green buttons)
- setting the boom configuration (red buttons)
- setting the reevings (white buttons)
- confirmation of the programming procedure

For simple operation, the computer guides the operator through the procedure step by step.

During the programming procedure the Load Moment Prewarning Light (3) and the Load Moment Limit Light (4) will light up and the dangerous crane movements will be interrupted.

4.1 Setting the Outrigger Configuration

At the beginning of the programming procedure the lights of the Outrigger Configuration buttons (12) start blinking, indicating that the operator has to select the outrigger configuration by pressing the appropriate button.

After the button has been pressed, the corresponding control light changes from blinking to permanent and the next step of the programming procedure will be started.

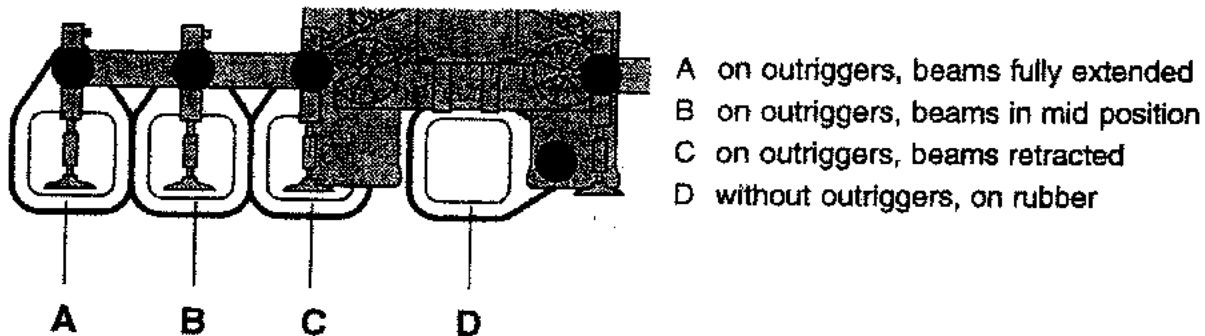

Note:

If a configuration is selected which is not available, the load display will indicate the error code E04 for approximately 10 seconds and the setting procedure starts anew.

4.2 Hoist Line Selection

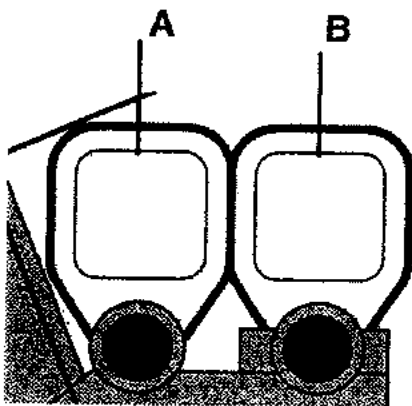

Subsequent to the setting procedure of the outrigger configuration the control lights of the Hoist Line Selection Buttons (10) start blinking, indicating that the operator has to select the hoist line by pressing the appropriate button.

After the button has been pressed, the corresponding control light changes from blinking to permanent and the next step of the programming procedure will be started.

Note:

If a configuration is selected which is not available, the load display will indicate the error code E04 for approximately 10 seconds and the setting procedure starts anew (ref. chapter 4.1).

4.3 Setting the Boom Configuration

Subsequent to the hoist line selection the control lights of the boom Configuration Buttons (12) start blinking, indicating that the operator has to select the outrigger configuration by pressing the appropriate button.

After the button has been pressed, the corresponding control light changes from blinking to permanent and the next step of the programming procedure will be started.

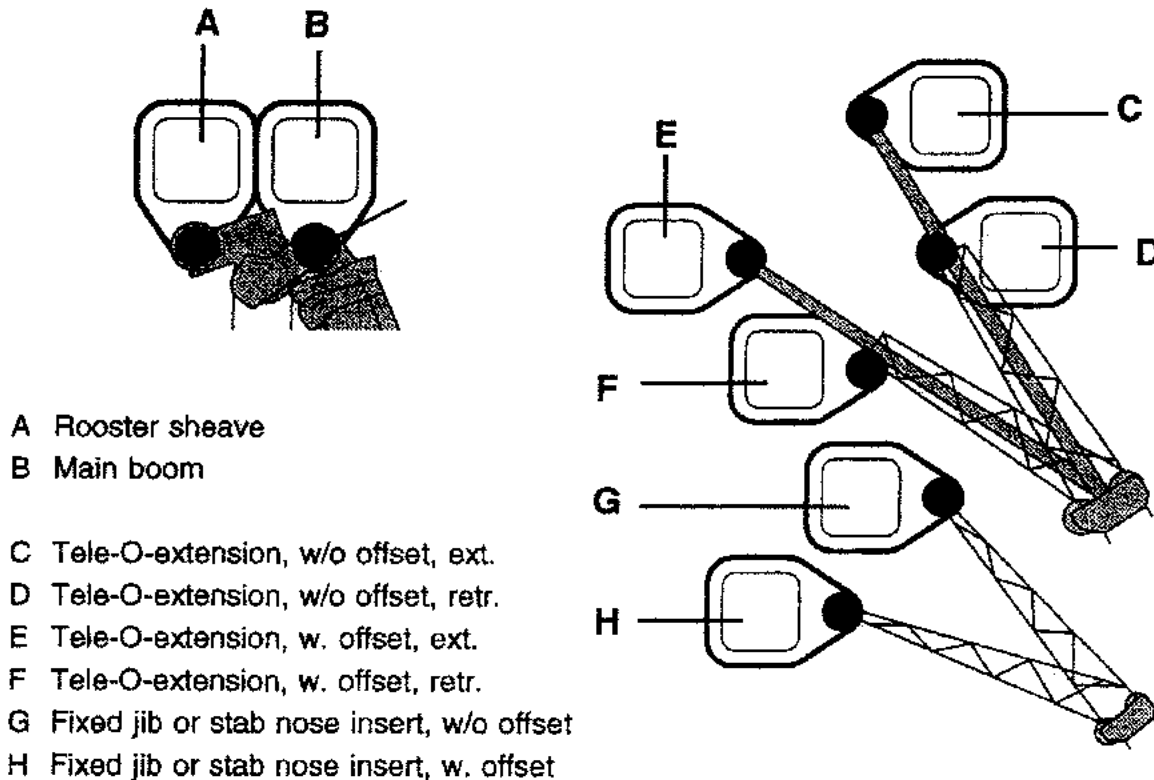
**Note:**

If a configuration is selected which is not available on the present crane, the system will not accept the selection and the load display will indicate the error code E04 for approximately 10 seconds (ref. chapter 4.1).

4.4 Setting the Reeving

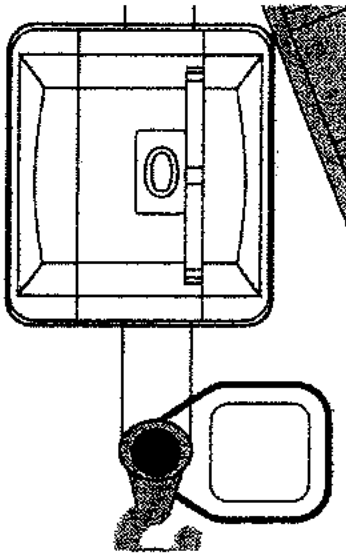

Subsequent to the setting procedure of the boom configuration the control light of the Reaving Selection Button (22) starts blinking.

The operator has to enter the number of falls (parts of line) by turning the Reaving switch (23) until the actual number of falls is displayed. To confirm the Reaving Selection Button (22) has to be pressed.

After the button has been pressed, the control light changes from blinking to permanent and the next step of the programming procedure will be started.

4.5 Confirmation of Programming Procedure

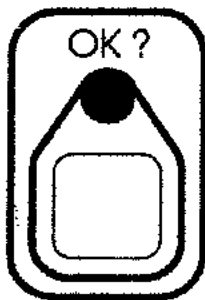

After setting the reeving the lights of the previously set buttons start blinking and the operator has now the possibility to check the programming. If the programming is coincident with the crane configuration, the Button "Confirmation of Programming Procedure" (16) has to be pressed.

Now the Programming Procedure is complete and the system is ready to operate.

Note:

After completion of the Programming Procedure, from every button group Outrigger Configuration (yellow buttons), Hoist Line Selection (green buttons), Boom Configuration (red buttons) and Reaving Selection (white buttons) one light has to on. If not, there must be a fault in the system (see chapter 7 "Troubleshooting").

5 Pre-Operation Inspection and Calibration Verification

Prior to operating the crane, the following electrical connections must be checked to ensure that the system is properly connected for the crane configuration.

Machines with only a Main Hoist

If the crane works only with the boom and without boom extension, no additional connections are necessary. However, be sure the weight of the anti two-block switch is properly installed on the main hoist load line. With even parts of hoisting line, the weight shall be attached to the dead-end line. With odd parts of hoisting line, the weight shall be attached to the line of lowest speed.

If the crane works with boom extension, the connecting cable shall be installed between the junction box on the boom extension and the boom junction box. The weight attached to the main hoist anti two-block switch shall be removed. In that case the anti two-block switch has to be locked with the red Anti Two-Block Retainer, which is fixed with a red lanyard at the anti two-block switch (described on pages 24 and 25). Then the weight shall be reattached to the boom extension anti two-block switch.

WARNING

Failure to re-position the anti two-block switch weight will prevent the overhoist system from functioning properly. No weight shall be on the main hoist anti two-block switch when the boom extension is being used.

Machines with Main and Auxiliary Hoists

If the boom extension *is not* in the operating position, the by-pass plug shall be installed in the main boom junction box. The weight of the main hoist anti two-block switch shall be installed.

If the boom extension *is* in the operating position, the connecting cable shall be installed between the junction boxes on the boom extension and the main boom. Weights shall also be attached to the anti two-block switches on both the main boom and boom extension.

If the boom extension is in the operating position and no load line is being used on main boom, to prevent injury or damage to equipment, the weight shall be removed from main boom switch. In that case the anti two-block switch has to be locked with the red Anti Two-Block Retainer, which is fixed with a red lanyard (not shown) at the anti two-block switch.

Installation of Anti Two-Block Retainer in Locking Position

Procedure (see Fig. 1 and 2):

1. Pull the cable out of the switch and bend back parallel to the boom and hold (1).
2. Slide the retainer from left side with it's slot over the cable between the crimped stop and the switch (2). Push it firmly straight onto the cable guide of the Anti Two-Block switch (3).

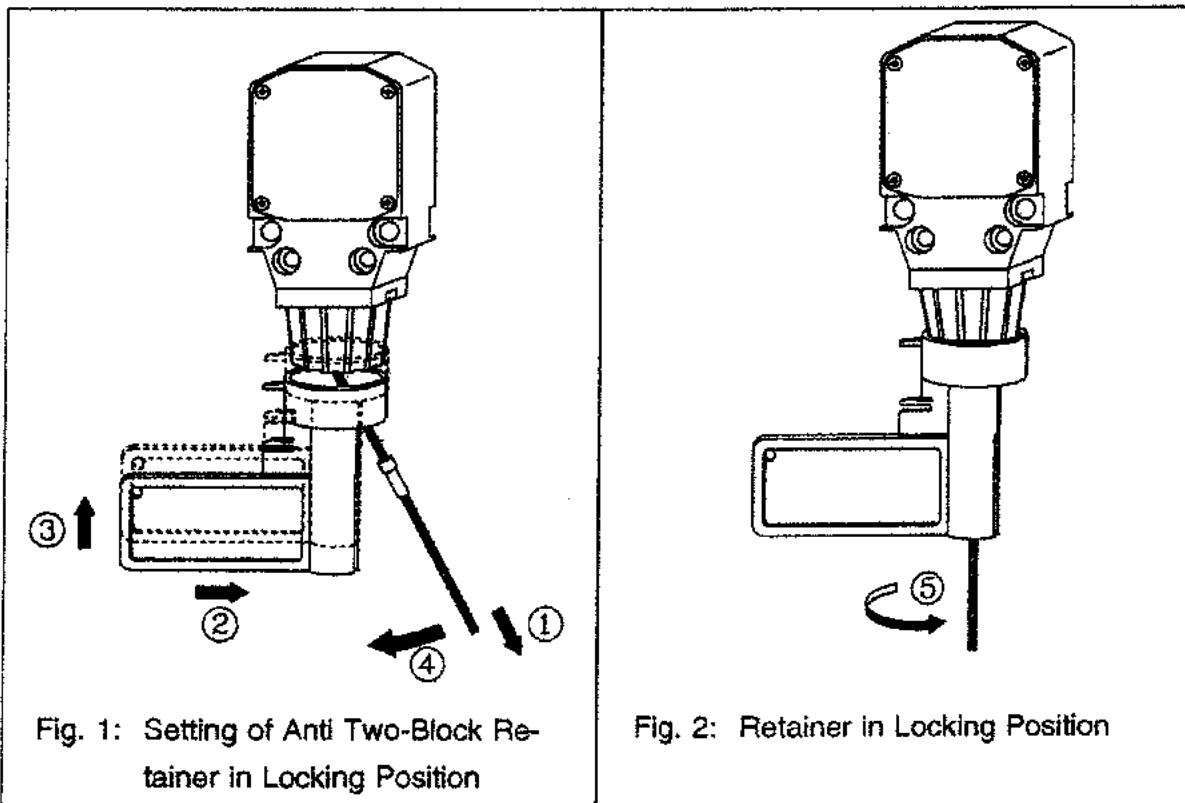

Fig. 1: Setting of Anti Two-Block Retainer in Locking Position

Fig. 2: Retainer in Locking Position

3. Straighten the cable completely into the slot and release the cable (4).
4. Turn the flag of the retainer for best visibility for the operator (5).

Removal and Storage of the Anti Two-Block Retainer

Procedure (see Fig. 3 and 4):

1. Pull the cable out of the switch (1) and bend back parallel to the boom and hold (2).
2. Move the retainer down (3) and then left (4) to remove it from the Anti Two-Block switch. Release the cable.
3. For storage slide the retainer from right side (5) over the Anti Two-Block switch until the clips (A) lock into the holes (B).

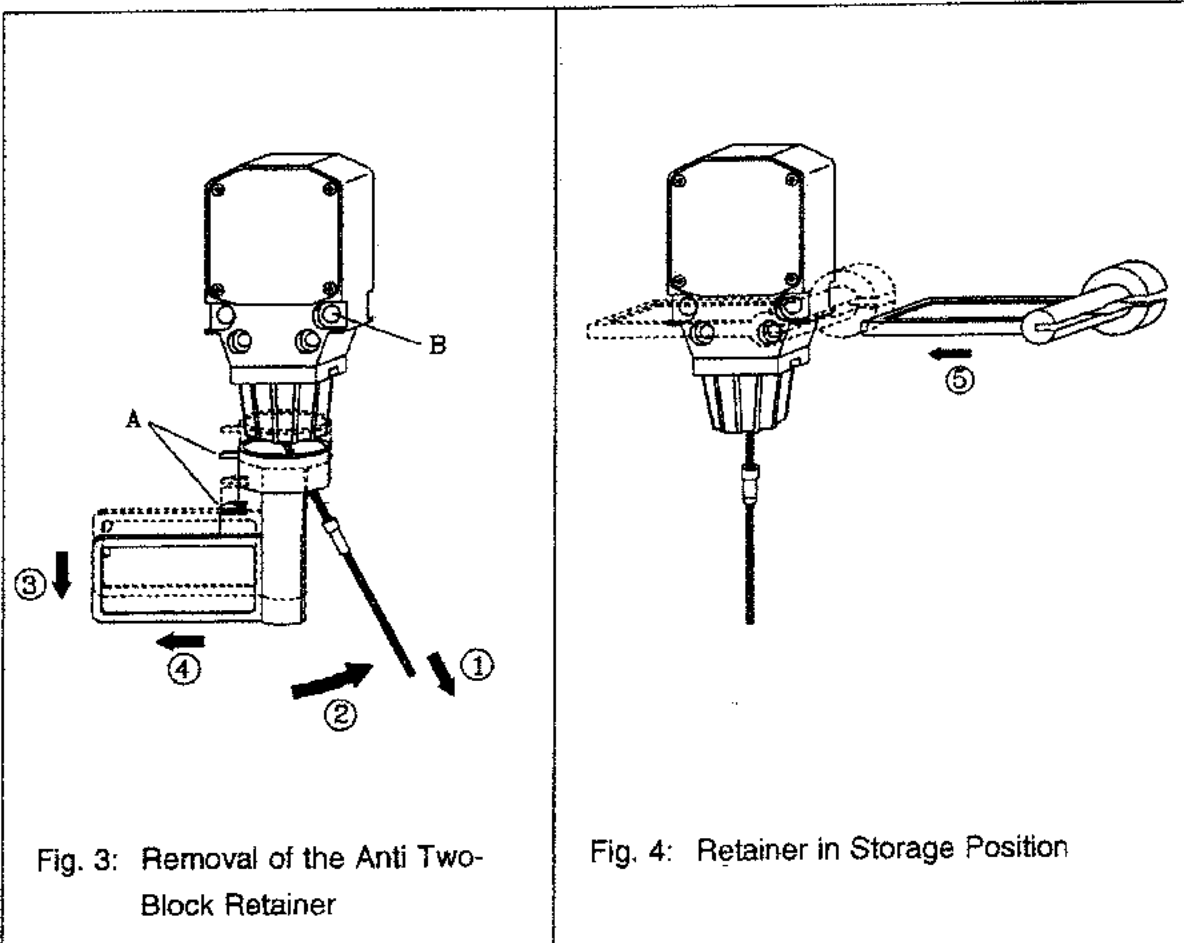

Fig. 3: Removal of the Anti Two-Block Retainer

Fig. 4: Retainer in Storage Position

Pre-Operation Inspection and Calibration Verification

After the electrical connections have been checked to insure that the system is properly connected for the crane configuration, the following checks shall be made:

1. Check the electrical wiring connecting the various parts of the system for physical damage.
2. Check the anti two-block switches and weights for free movement.
3. Check the spring-loaded cable reel to be sure it is free to rotate, has tension and the cable is reeled properly.

WARNING

The following tests shall be performed with care to prevent damage to the machine or injury to personnel. Proper functioning of the system requires successful completion of these tests before operating the machine.

If the operator cannot see the load handling device approaching the boom nose, he shall have an assistant (signal person) watch the load handling device. The operator shall be prepared to stop the machine immediately should the LMI system not function properly as indicated by lighting the red warning light (24), sounding the audible alarm (18) and locking the crane movements, hoist up, telescope out and boom down.

Check the anti two-block alarm light (24) and the audible alarm (18) by performing one of the following tests:

1. By manually lifting the weight attached to the anti two-block switches. When the weight is lifted, the audible alarm (18) should sound, the anti two-block alarm light (24) should light.
2. Slowly raise the main boom load handling device to create a potential two-block condition. When the load handling device lifts the weight, the audible alarm (18) should sound, the anti

- two- block alarm light (24) should light and the motion of the load handling device should be stopped. Lower the load handling device slightly to eliminate this condition.
3. Slowly lower the boom to create a potential two-block condition. When the load handling device lifts the weight, the audible alarm (18) should sound, the anti two-block alarm light (24) should light and the boom lowering function should be stopped. Lower the load handling device slightly to eliminate this condition.
 4. Slowly extend (telescope) the boom to create a potential two-block condition. When the load handling device lifts the weight, the audible alarm (18) should sound, the anti two-block alarm light (24) should light and the boom telescope out function should be stopped. Lower the load handling device slightly to eliminate this condition.

WARNING

If the light and audible alarm do not function as described and the crane movements are not stopped, the system is not working properly. The malfunction shall be corrected before operating the crane.

5. If the crane is equipped with a boom extension, repeat the test procedure for the boom extension anti two-block switch.
6. Check that the display of the main boom length agrees with the actual boom length.
7. Check that the display of the main boom angle agrees with the actual boom angles.
8. Check that the display of the operating radius of the crane agrees with the actual radius.

9. Check the load display by lifting a load of known weight. The accuracy of the load indication shall be within the tolerance of SAE J159.

Operation

After being properly checked, the LMI is operational. The operator shall be thoroughly familiar with all controls of the LMI and he shall properly set the Reeving Switch (23) before operating the crane. The proper function of the system shall be checked by lifting a load of known weight and comparing the load to the information displayed on the LMI.

Rated loads include the weight of the hook block, slings, and auxiliary load handling devices. Their combined weights shall be subtracted from the listed load capacities as stated on the load capacity chart to obtain the net load to be lifted.

WARNING

If any of the displays reflect a deviation between displayed and actual values an authorized PAT service representative shall be called for repair of the system or reverification of the crane's LMI calibration.

WARNING

Any structural modifications or changes to the crane shall require reverification of the crane's LMI calibration.

6 SERVICE AND MAINTENANCE

Daily maintenance of the load moment indicator consists of inspecting:

1. The electrical wiring connecting the various parts of the system. If electrical wiring is damaged, it shall be replaced immediately.
2. If the insulation is worn on the length sensor cable or cable guides are damaged, these parts shall be replaced.
3. Check the anti two-block limit switches for freedom of movement.
4. The cable reel shall be under tension to operate properly.
5. Check the pressure transducers at the lift cylinder(s) and the connecting hoses for oil leakage.

Other than correcting the problems identified in the Malfunctions Table and replacing faulty mechanical parts and cables, no other repairs shall be performed by non expert personnel.

7 TROUBLESHOOTING

General

In case of a malfunction of the system, the load display (20) will indicate a code which identifies the system malfunction.

The error codes listed in the Malfunction Table will identify various faults which can occur with the LMI. Following the Malfunction Table are pages which explain each fault and describe the action which shall be taken to correct the fault.

Faults within the electronic microprocessor shall be repaired by factory trained service personnel. When these faults occur, the competent service organization shall be contacted.

Malfunction Table	
Error Code	Error
E01	Fallen below the radius or above angle range
E02	Radius range exceeded or fallen below angle range
E03	Boom position is out of the permissible working area
E04	Operating mode not existing
E05	Prohibited length range

NOTE:

If there is any Error Code displayed on the console which is not listed in the Malfunctions Table you shall call the Local Distributor.

Operating Errors

Malfunctions in the system which are caused by range exceedings or operating errors by the crane operator himself are indicated on the display together with an explanation. These error codes are E01, E02, E03, E04, and E05 and they can normally be eliminated by the crane operator himself.

Error Code	Cause	Elimination
E01	Fallen below the minimum radius or above the angle given in the load capacity chart due to raising the boom too far.	Lower boom back to a radius or angle given in the load capacity chart.
E02	The maximum radius or minimum angle given in the load capacity chart was exceeded due to lowering the boom too far.	Raise boom back to a radius or angle given in the load capacity chart.
E03	Boom position is out of the permissible working area (over front).	Move boom back to the permissible working area. See lifting diagram in the load capacity charts.
E04	Operating mode switch in the console set incorrectly.	Set operating mode switch correctly to the code assigned to the operating mode of the crane.
	Operating mode is not permissible with the actual crane configuration, boom position or area definition.	Be sure crane is set up according to proper operating configurations.

E05	Boom was telescoped too far or not far enough, you may only operate up to a certain maximum or minimum boom length or with load curves for boom extension where you have to telescope the main boom to a certain length.	Telescope boom to correct length, given in the load capacity chart.
	Length sensor adjustment changed i.e. length sensor cable slid off the length sensor drum.	For elimination refer to service manual.